



Haziran 2023  
Fiyat Listesi



“Aydınlatmada  
Tek Adres”



41  
aydınlık yıl

### Cruzo şimdi CB, ENEC Belgeli

- W 300-1000W**
- 100.000h Driver Ömrü**
- 10kV Dahili Parafudr**
- IK10 Gövde**
- IP66, Toz ve Su Almaz!**
- Gerilim Dalgalanmalarından Etkilenmez  
100-277Vac**



#### Lens Opsiyonları

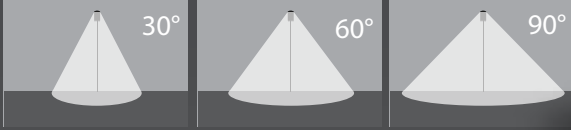

Ürün Videosu



**Yüksek Güçlü  
LED Projektörler Sayfa 53**



### Diğer Projektörler



Ria IP66



Ria Med G2



Sterio IP66



Lecto















# Pelsan



## Profesyonel Solar Armatürleri

- MPPT şarj regülatörü ile **%35 daha etkili şarj!**
- LifePo4 batarya ile **daha uzun ömürlüdür!**
- Elektronik kontrol ünitesi sayesinde **2,5 güne kadar otonom sağlar!**
- Astro DIM ile armatürün **çalışma senaryosu belirlenir!**
- **Uzaktan kumanda** ile kontrol edilebilir.



<b>08</b> Backlight Ofis Armatürleri	
<b>09</b> Sıva Üstü Backlight Ofis Armatürleri	
<b>12</b> Clip-in Backlight Ofis Armatürleri	
<b>13</b> Steril Ortam ve Hastane Armatürleri	
<b>14</b> UGR Ofis / Lineer Armatürleri	
<b>16</b> Lineer Armatürler	
<b>18</b> Aplikler	
<b>19</b> İç Mekan Gloplar	
<b>20</b> Downlight Armatürler	
<b>24</b> Sensörlü Armatürler	
<b>25</b> IP66 Tavan/Duvar Armatürler	
<b>26</b> Sensörler	
<b>27</b> Acil Aydınlatma Armatürleri	

<p><b>29</b> Acil Aydınlatma ve Yönlendirme Armatürleri</p>	
<p><b>32</b> Süpermarket Armatürleri</p>	
<p><b>33</b> Bant Armatürleri</p>	
<p><b>35</b> Etanj Armatürleri</p>	
<p><b>36</b> Özel Etanj Armatürler</p>	
<p><b>37</b> Alüminyum Etanj Armatürler</p>	
<p><b>38</b> PC Etanj Armatürler</p>	
<p><b>39</b> LED Tube Etanj</p>	
<p><b>40</b> Benzinlik Armatürleri</p>	
<p><b>41</b> Sabit Gerilim 24V Armatürler</p>	
<p><b>42</b> Yüksek Tavan Armatürleri</p>	
<p><b>48</b> Alçak Tavan Armatürleri</p>	
<p><b>49</b> Ex-Proof Armatürler</p>	

<b>52</b> Wallwasher	
<b>53</b> Yüksek Güçlü Projektörler	
<b>54</b> Profesyonel Projektörler	
<b>56</b> Projektörler	
<b>58</b> Profesyonel Solar Aydınlatma Armatürleri	
<b>59</b> Solar Aydınlatma Armatürleri	
<b>60</b> Yol ve Cadde Armatürleri	
<b>64</b> Park Bahçe Aydınlatma Armatürleri	
<b>70</b> Park Bahçe Aydınlatma Armatürleri	
<b>72</b> Direkler	
<b>73</b> Bolardlar	

<b>75</b> Çimen Armatürleri	
<b>76</b> Set Üstü Armatürler	
<b>77</b> Dış Mekan Aplikler	
<b>78</b> Park Bahçe Aplikler	
<b>79</b> LED Lambalar	
<b>80</b> LED Tube	
<b>81</b> Balastlar & Kitler	
<b>83</b> Anahtar ve Prizler	
<b>84</b> Grup Prizler	
<b>85</b> Grup Prizler & Aksesuarlar	
<b>86</b> Sertifikalar	

# Pelsan Backlight Ofis Armatürleri

## Kurum Şartnamelerine Uygun

5  
YIL  
GARANTİ



Isoled  
Sıva Altı Ofis Armatürü



Dekoled  
Sıva Üstü Ofis Armatürü



TSE Belgeli



ENEC Belgeli Sürücü



50.000 Saatlik Ömür



Lensli Modül



PF > 0,95

**Isoled 60x60**  
Sıva Altı



IP 40 ● 3000K ● 4000K ● 6500K

Lensli Modül

Kod No	Özellikler	Koli Adedi	Fiyat
111474	36W 60X60 S.A. 4000K	6	36,10 \$
111475	36W 60X60 S.A. 6500K	6	36,10 \$

**Isoled 30x30**  
Sıva Altı



IP 40 ● 3000K ● 4000K ● 6500K

Tarak PCB

Kod No	Özellikler	Koli Adedi	Fiyat
113676	12W 30X30 S.A. 4000K	5	20,30 \$
113677	12W 30X30 S.A. 6500K	5	20,30 \$

**Isoled 30x60**  
Sıva Altı

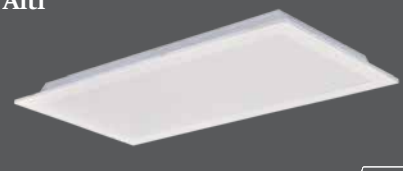

IP 40 ● 3000K ● 4000K ● 6500K

Lensli Modül

Kod No	Özellikler	Koli Adedi	Fiyat
111821	17W 30x60 S.A. 4000K	5	30,70 \$
111822	17W 30x60 S.A. 6500K	5	30,70 \$

**Isoled 30x120**  
Sıva Altı



IP 40 ● 3000K ● 4000K ● 6500K

Lensli Modül

Kod No	Özellikler	Koli Adedi	Fiyat
113008	36W 30x120 S.A. 4000K	4	49,10 \$
113009	36W 30x120 S.A. 6500K	4	49,10 \$

**Isoled 60x120**  
Sıva Altı



IP 40 ● 4000K ● 6500K

Lensli Modül

Kod No	Özellikler	Koli Adedi	Fiyat
113246	72W 60x120 4000K	20	98,10 \$
113247	72W 60x120 6500K	20	98,10 \$

**Isoled UGR**  
Sıva Altı



IP 40 ● 3000K ● 4000K ● 6500K

Lensli Modül

Kod No	Özellikler	Koli Adedi	Fiyat
113538	36W 60X60 S.A. 4000K	5	42,70 \$
113539	36W 60X60 S.A. 6500K	5	42,70 \$

## Opsiyonlar

Kod No	Özellikler	Koli Adedi	Fiyat
327764	Isoled & Dekoled Acil Aydınlatma Kiti (1 saat)	1	26,00 \$
327251	Isoled & Dekoled Acil Aydınlatma Kiti (3 saat)	1	30,30 \$
323795	Isoled Alçıpan Yayı (4 adet) (60x60 için)	1	3,51 \$
325628	Isoled Alçıpan Yayı (2 adet) (30x30 için)	1	1,80 \$

Özellikler	Koli Adedi	Fiyat Farkı
1-10V Dim	1	31,25 \$
DALI Dim	1	31,25 \$
PMMA Difüzör	1	5,50 \$



# Sıva Üstü Backlight Ofis Armatürleri

**Dekoled 60x60**  
Sıva Üstü



IP 40  3000K  4000K  6500K

Kod No	Özellikler	Koli Adedi	Fiyat
111499	36W 60x60 S.Ü. 4000K	6	42,30 \$
111500	36W 60x60 S.Ü. 6500K	6	42,30 \$

**60x60 Radar Sensörlü**  
Sıva Üstü



IP 40  3000K  4000K  6500K

Kod No	Özellikler	Koli Adedi	Fiyat
108786	36W 60x60 S.Ü. 6500K Radar Sens.	5	65,40 \$
108785	36W 60x60 S.Ü. 6500K Radar Sens. + Acil Ayd. Kit	5	91,40 \$

**Dekoled 30x30**  
Sıva Üstü



IP 40  3000K  4000K  6500K

Kod No	Özellikler	Koli Adedi	Fiyat
113895	12W 30x30 S.Ü. 4000K	5	24,55 \$
113896	12W 30x30 S.Ü. 6500K	5	24,55 \$

**30x30 Radar Sensörlü**  
Sıva Üstü





IP 40  3000K  4000K  6500K

Kod No	Özellikler	Koli Adedi	Fiyat
108780	12W 30x30 S.Ü. 6500K Radar Sens.	5	40,50 \$
109086	12W 30x30 S.Ü. 6500K Radar Sens. + Acil Ayd. Kit	5	66,50 \$

**Dekoled 30x120**  
Sıva Üstü



IP 40  3000K  4000K  6500K

Kod No	Özellikler	Koli Adedi	Fiyat
113041	36W 30x120 S.Ü. 4000K	4	57,50 \$
113042	36W 30x120 S.Ü. 6500K	4	57,50 \$

**Dekoled 30x60**  
Sıva Üstü



IP 40  3000K  4000K  6500K

Kod No	Özellikler	Koli Adedi	Fiyat
111839	17W 30x60 S.Ü. 4000K	5	36,10 \$
111840	17W 30x60 S.Ü. 6500K	5	36,10 \$

**Dekoled 60x120**  
Sıva Üstü



IP 40  3000K  4000K  6500K

Kod No	Özellikler	Koli Adedi	Fiyat
113353	72W 60x120 S.Ü. 4000K	2	127,10 \$
113354	72W 60x120 S.Ü. 6500K	2	127,10 \$

**Seoled1 60x60**  
Sıva Üstü



IP 40  3000K  4000K  6500K

Kod No	Özellikler	Koli Adedi	Fiyat
109516	36W 60x60 S.Ü. 6500K	4	74,60 \$

# Pelsan Backlight Ofis Armatürleri

## Kurum Şartnamelerine Uygun

5  
YIL  
GARANTİ



Isoled  
Sıva Altı Ofis Armatürü



Dekoled  
Sıva Üstü Ofis Armatürü



TSE Belgeli



Avrupa Menşei ENEC Sürücü



+118 lm/W



50.000 Saatlik Ömür



Tarak PCB



PF > 0,95



PMMA Difüzör



55mm Kasa Kalınlığı

**Isoled 60x60**  
Sıva Altı



IP 40 ● 3000K ● 4000K ● 6500K

Tarak PCB

Kod No	Özellikler	Koli Adedi	Fiyat
111411	36W 60X60 S.A. 4000K	6	46,35 \$
111412	36W 60X60 S.A. 6500K	6	46,35 \$

**Isoled 30x30**  
Sıva Altı



IP 40 ● 3000K ● 4000K ● 6500K

Tarak PCB

Kod No	Özellikler	Koli Adedi	Fiyat
111342	12W 30X30 S.A. 4000K	5	23,30 \$
111343	12W 30X30 S.A. 6500K	5	23,30 \$

**Isoled 30x60**  
Sıva Altı

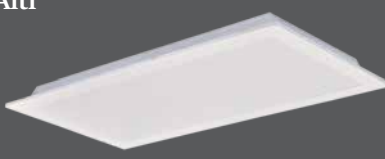

IP 40 ● 3000K ● 4000K ● 6500K

Tarak PCB

Kod No	Özellikler	Koli Adedi	Fiyat
111461	17W 30x60 S.A. 4000K	5	39,80 \$
111462	17W 30x60 S.A. 6500K	5	39,80 \$

**Isoled 30x120**  
Sıva Altı



IP 40 ● 3000K ● 4000K ● 6500K

Tarak PCB

Kod No	Özellikler	Koli Adedi	Fiyat
111464	36W 30x120 S.A. 4000K	4	62,10 \$
111465	36W 30x120 S.A. 6500K	4	62,10 \$

**Isoled 60x120**



IP 40 ● 4000K ● 6500K

Tarak PCB

Kod No	Özellikler	Koli Adedi	Fiyat
113369	72W 60x120 S.A. 4000K	20	116,60 \$
113370	72W 60x120 S.A. 6500K	20	116,60 \$

**Divaled Endirekt**  
Sıva Altı / Sıva Üstü



IP 20 ● 3000K ● 4000K ● 6500K

UGR < 16

Kod No	Özellikler	Koli Adedi	Fiyat
108125	42W 60x60 S.A. 4000K	4	67,40 \$
110601	42W 60x60 S.Ü. 4000K	4	81,30 \$

### Opsiyonlar

Kod No	Özellikler	Koli Adedi	Fiyat
327764	Isoled & Dekoled Acil Aydınlatma Kiti (1 saat)	1	26,00 \$
327251	Isoled & Dekoled Acil Aydınlatma Kiti (3 saat)	1	30,30 \$
323795	Isoled Alçıpan Yayı (4 adet) (60x60 için)	1	3,51 \$
325628	Isoled Alçıpan Yayı (2 adet) (30x30 için)	1	1,80 \$

Özellikler	Koli Adedi	Fiyat Farkı
1-10V Dim	1	31,25 \$
DALI Dim	1	31,25 \$
PMMA Dif Farkı	1	5,50 \$

# Sıva Üstü Backlight Ofis Armatürleri Pelsan

**Dekoled 60x60**  
Sıva Üstü



IP 40   

Tarak PCB

Kod No	Özellikler	Koli Adedi	Fiyat
111439	36W 60x60 S.Ü. 4000K	6	53,85 \$
111440	36W 60x60 S.Ü. 6500K	6	53,85 \$

**60x60 Radar Sensörlü**  
Sıva Üstü



IP 40   



Tarak PCB

Acil

Kod No	Özellikler	Koli Adedi	Fiyat
108786	33W 60x60 S.Ü. 6500K	5	65,40 \$
108785	33W 60x60 S.Ü. 6500K	5	91,40 \$

**Dekoled 30x30**  
Sıva Üstü



IP 40   

Tarak PCB

Kod No	Özellikler	Koli Adedi	Fiyat
111357	12W 30x30 S.Ü. 4000K	5	27,05 \$
111358	12W 30x30 S.Ü. 6500K	5	27,05 \$

**30x30 Radar Sensörlü**  
Sıva Üstü



IP 40   

Acil

Kod No	Özellikler	Koli Adedi	Fiyat
108780	12W 30x30 S.Ü. 6500K	5	40,50 \$
109086	12W 30x30 S.Ü. 6500K	5	66,50 \$

**Dekoled 30x120**  
Sıva Üstü



IP 40   

Tarak PCB

Kod No	Özellikler	Koli Adedi	Fiyat
111458	36W 30x120 S.Ü. 4000K	4	72,10 \$
111459	36W 30x120 S.Ü. 6500K	4	72,10 \$

**Dekoled 30x60**  
Sıva Üstü



IP 40   

Tarak PCB

Kod No	Özellikler	Koli Adedi	Fiyat
111455	17W 30x60 S.Ü. 4000K	5	45,55 \$
111456	17W 30x60 S.Ü. 6500K	5	45,55 \$

**Dekoled 60x120**  
Sıva Üstü







IP 40   

Tarak PCB

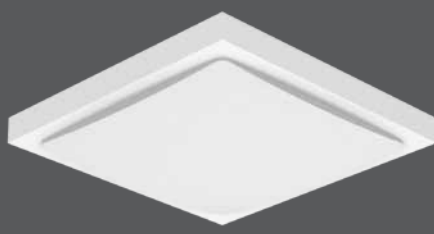
Kod No	Özellikler	Koli Adedi	Fiyat
111392	72W 60x120 S.Ü. 4000K	2	131,60 \$
111393	72W 60x120 S.Ü. 6500K	2	131,60 \$

**Seoled1 60x60**  
Sıva Üstü



IP 40   

Tarak PCB

Kod No	Özellikler	Koli Adedi	Fiyat
109516	36W 60x60 S.Ü. 6500K	4	74,60 \$

## Pelsan Clip-in Backlight Ofis Armatürleri

**Clip-in Isoled**  
60x60

IP 40 ⊕ ● 3000K ● 4000K ● 6500K

Lensli Modül

56mm

Kod No	Özellikler	Koli Adedi	Fiyat
111480	36W 60X60 Clip-in 4000K	6	39,40 \$
111481	36W 60X60 Clip-in 6500K	6	39,40 \$

**Clip-in Isoled**  
30x30

IP 40 ⊕ ● 3000K ● 4000K ● 6500K

Tarak PCB

56mm

Kod No	Özellikler	Koli Adedi	Fiyat
113670	12W 30x30 Clip-in 4000K	5	23,60 \$
113671	12W 30x30 Clip-in 6500K	5	23,60 \$

**Clip-in Nora**  
60x60

IP 40 ⊕ ● 3000K ● 4000K ● 6500K

40mm

Kod No	Özellikler	Koli Adedi	Fiyat
113791	36W 60x60 Clip-in 4000K	5	52,40 \$
113792	36W 60x60 Clip-in 6500K	5	52,40 \$

**Clip-in Nora**  
30x30

IP 40 ⊕ ● 3000K ● 4000K ● 6500K

40mm

Kod No	Özellikler	Koli Adedi	Fiyat
113778	12W 30x30 Clip-in 4000K	4	33,55 \$
113779	12W 30x30 Clip-in 6500K	4	33,55 \$

**Clip-in Nora**  
60x60

IP 40 ⊕ ● 3000K ● 4000K ● 6500K

40mm

Kod No	Özellikler	Koli Adedi	Fiyat
113793	36W 60x60 Clip-in 4000K	5	52,40 \$
113794	36W 60x60 Clip-in 6500K	5	52,40 \$

**Clip-in Nora**  
30x30

IP 40 ⊕ ● 3000K ● 4000K ● 6500K

40mm

Kod No	Özellikler	Koli Adedi	Fiyat
113780	12W 30x30 Clip-in 4000K	4	33,55 \$
113781	12W 30x30 Clip-in 6500K	4	33,55 \$

**Clip-in IP65**  
60x60

IP 65 ⊕ ● 3000K ● 4000K ● 6500K

50mm

IP65

Kod No	Özellikler	Koli Adedi	Fiyat
113261	36W 60x60 Clip-in 4000K	2	63,80 \$
111622	36W 60x60 Clip-in 6500K	2	63,80 \$

**Clip-in IP65**  
30x30

IP 65 ⊕ ● 3000K ● 4000K ● 6500K

50mm

IP65

Kod No	Özellikler	Koli Adedi	Fiyat
113657	12W 30x30 Clip-in 4000K	2	37,80 \$
113658	12W 30x30 Clip-in 6500K	2	37,80 \$

# Steril Ortam ve Hastane Armatürleri

**IP65 LED Steril**  
Sıva Altı Temperli Camlı



UGR<19

IP65

IP 65 ● 3000K ● 4000K ● 6500K

Kod No	Özellikler	Koli Adedi	Fiyat
110607	36W 60x60 S.A. 4000K IP65 Steril	2	127,50 \$
110608	36W 60x60 S.A. 6500K IP65 Steril	2	127,50 \$

**Endirekt Steril**  
Sıva Altı 60x60



IP65

IP 65 ● 3000K ● 4000K ● 6500K

Kod No	Özellikler	Koli Adedi	Fiyat
113439	42W 60x60 S.A. 4000K IP65	5	127,50 \$
113440	42W 60x60 S.A. 6500K IP65	5	127,50 \$

**IP65 LED Steril**  
Sıva Altı Temperli Camlı



IP65

IP 65 ● 3000K ● 4000K ● 6500K

Kod No	Özellikler	Koli Adedi	Fiyat
109776	36W 60x60 S.A. 4000K IP65 Steril	2	95,50 \$
109777	36W 60x60 S.A. 6500K IP65 Steril	2	95,50 \$

**IP65 LED Steril**  
Sıva Üstü Temperli Camlı



IP65

IP 65 ● 3000K ● 4000K ● 6500K

Kod No	Özellikler	Koli Adedi	Fiyat
109905	36W 60x60 IP65 4000K S.Ü. Steril	2	105,50 \$
109906	36W 60x60 IP65 6500K S.Ü. Steril	2	105,50 \$

**IP65 LED Steril**  
Sıva Altı 60x60



IP65

IP 65 ● 3000K ● 4000K ● 6500K

Kod No	Özellikler	Koli Adedi	Fiyat
113277	36W 60x60 S.A. 4000K IP65 Steril	5	60,50 \$
113278	36W 60x60 S.A. 6500K IP65 Steril	5	60,50 \$

**IP65 LED Steril**  
Sıva Altı 30x30



IP65

IP 65 ● 3000K ● 4000K ● 6500K

Kod No	Özellikler	Koli Adedi	Fiyat
113695	12W 30x30 S.A. 4000K IP65 Steril	5	34,50 \$
113696	12W 30x30 S.A. 6500K IP65 Steril	5	34,50 \$

**Negatoskop**  
Sıva Üstü



678mm 103mm 500mm

IP 40 ● 4000K ● 6500K

Kod No	Özellikler	Koli Adedi	Fiyat
106101	42W LED 60X60 S.Ü.6500K	1	208,50 \$

**Negatoskop**  
Sıva Üstü



1200mm 103mm 500mm

IP 40 ● 4000K ● 6500K

Kod No	Özellikler	Koli Adedi	Fiyat
106103	84W LED 60X120 S.Ü.6500K	1	288,50 \$

## Pelsan UGR Ofis Armatürleri

### Isoled UGR Sıva Altı



### Mikro Prizmatik Difüzör UGR<19



- Kamaşma önleyici difüzör
- +100lm/W verimlilik
- ENEC Belgeli Sürücü

IP 40 3000K 4000K 6500K

Kod No	Özellikler	Koli Adedi	Fiyat
113538	36W 60x60 S.A. 4000K	6	42,70 \$
113539	36W 60x60 S.A. 6500K	6	42,70 \$



### Nora UGR Sıva Altı 60x60



### Kamaşma Önleyici Optik Tasarım

UGR<9

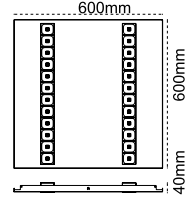

IP 40 3000K 4000K 6500K

Kod No	Özellikler	Koli Adedi	Fiyat
113789	36W 60x60 S.A. 4000K RAL9005	5	49,90 \$
113790	36W 60x60 S.A. 6500K RAL9005	5	49,90 \$

### Nora UGR Sıva Altı 60x60



### Kamaşma Önleyici Optik Tasarım

UGR<19

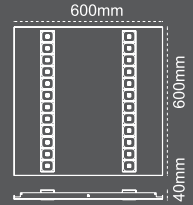

IP 40 3000K 4000K 6500K

Kod No	Özellikler	Koli Adedi	Fiyat
113787	36W 60x60 S.A. 4000K RAL9016	5	49,90 \$
113788	36W 60x60 S.A. 6500K RAL9016	5	49,90 \$

### Divaled Endirekt Sıva Altı / Sıva Üstü



### Endirekt Aydınlatma

- Ultra Görsel Konfor
- Estetik Tasarım
- Soft Işık



IP 20 3000K 4000K 6500K

Kod No	Özellikler	Koli Adedi	Fiyat
108125	42W 60x60 S.A. 4000K	4	67,40 \$
108408	42W 60x60 S.A. 6500K	4	67,40 \$
110601	42W 60x60 S.Ü. 4000K	4	81,30 \$
110602	42W 60x60 S.Ü. 6500K	4	81,30 \$

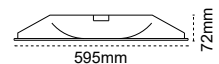



**Kamaşma Önleyici  
Optik Tasarım**

## Nora UGR<19 Linear Sıva Üstü

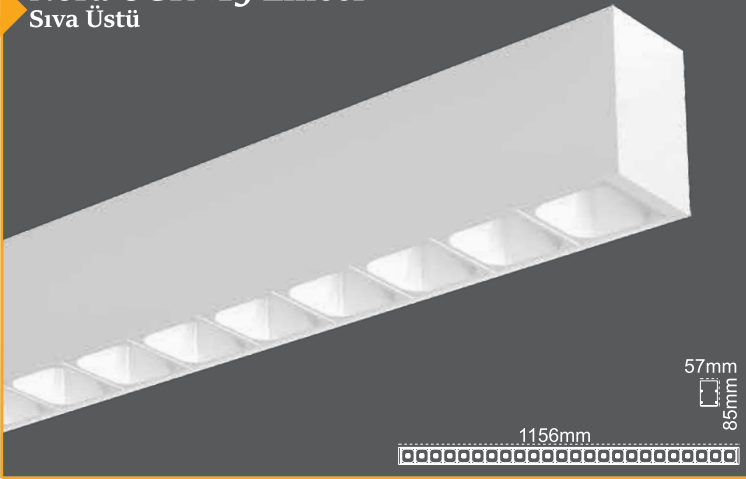

### Tüm Tavan Tiplerine Uygun



Kod No	Özellikler	Koli Adedi	Fiyat
110674	14W 4000K 580mm	1	50,75 \$
110676	20W 4000K 865mm	1	66,90 \$
110678	28W 4000K 1150mm	1	81,40 \$
110681	42W 4000K 1435mm	1	108,90 \$

## Nora UGR<16 Linear Sıva Üstü



### Tüm Tavan Tiplerine Uygun

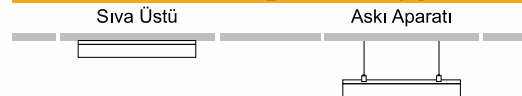

Kod No	Özellikler	Koli Adedi	Fiyat
110673	14W 4000K 580mm	1	50,75 \$
110675	20W 4000K 865mm	1	66,90 \$
110677	28W 4000K 1150mm	1	81,40 \$
110680	42W 4000K 1435mm	1	108,90 \$

## Opsiyon Farkları

Kod No	Özellikler	Koli Adedi	Fiyat
304906	Askı Aparatı 100 cm (2 adet)	1	4,30\$
304915	Askı Aparatı 150 cm (2 adet)	1	5,30\$
317986	Askı Rozans Takımı 150 cm Siyah (2 adet)	1	5,30\$
205224	Linear Birleştirme Aparatı Takımı (2 adet)	1	2,20\$

# Pelsan Lineer Armatürler

Eterna  
Sonsuzluğa Uzanan  
Konforlu Aydınlatma

## Sonsuz Lineer Bağlantı

Bağlantı aparatları ile ürüne müdahale edilmeksizin dışardan kesintisiz lineer bağlantı yapılır.

## Tüm Tavan Tiplerine Uygun

Sıva Üstü

Askı Aparatı

Sıva Altı

RAL 9005

RAL 9006

RAL 9016

• LED Çip ( LM80-TM218) • ENEC Belgeli Sürücü • Acil Aydınlatma • DALI Opsiyonu

## Eterna (57mm) Sıva Üstü



57 mm  
85 mm

IP 40 ⊕ ● 3000K ● 4000K ● 6500K

Kod No	Özellikler	Koli Adedi	Fiyat
108964	14W 4000K 600mm	1	39,40 \$
108965	20W 4000K 900mm	1	51,80 \$

IP 40 ⊕ ● 3000K ● 4000K ● 6500K

Kod No	Özellikler	Koli Adedi	Fiyat
108966	28W 4000K 1200mm	1	63,10 \$
108967	42W 4000K 1500mm	1	84,40 \$

## Eterna (57mm) Sıva Altı



77 mm

IP 20 ⊕ ● 3000K ● 4000K ● 6500K

Kod No	Özellikler	mm	Koli Adedi	Fiyat
108898	14W 4000K 640mm	625X62	1	39,40 \$
108899	20W 4000K 920mm	895X62	1	51,80 \$

IP 20 ⊕ ● 3000K ● 4000K ● 6500K

Kod No	Özellikler	mm	Koli Adedi	Fiyat
108900	28W 4000K 1240mm	1225X62	1	63,10 \$
108901	42W 4000K 1520mm	1505X62	1	84,40 \$

## Opsiyon Farkları

Kod No	Özellikler	Koli Adedi	Fiyat
304906	Askı Aparatı 100 cm (2 adet)	1	4,30\$
304915	Askı Aparatı 150 cm (2 adet)	1	5,30\$
317986	Askı Rozans Takımı 150 cm Siyah (2 adet)	1	5,30\$
205224	Lineer Birleştirme Aparatı Takımı (2 adet)	1	2,20\$



**Trenta G2**  
**ŞOK FİYAT**  
**37,00 \$**

**Trenta G2 (33mm)**

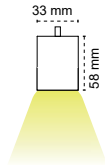

IP 40 4000K 6500K

Kod No	Özellikler	Koli Adedi	Fiyat
113031	36W 4000K 1020mm	12	37,00 \$
114192	36W 4000K 1020mm Acil Aydınlatma Kiti	12	87,00 \$

**Eterna Endirekt (47mm)**

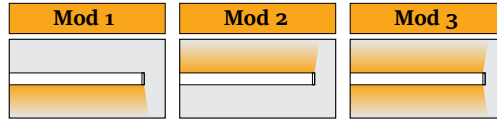
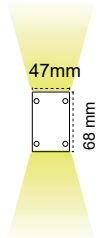

IP 40 3000K 4000K 6500K

Kod No	Özellikler	Koli Adedi	Fiyat
206015	26W-16W 4000K 900mm	1	104,00 \$
206016	34W-18W 4000K 1200mm	1	114,90 \$
206017	44W-24W 4000K 1470mm	1	136,80 \$
206018	60W-40W 4000K 2000mm	1	191,50 \$

**Lorenta (33mm)**  
Sarkıt / Opal

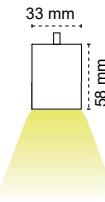
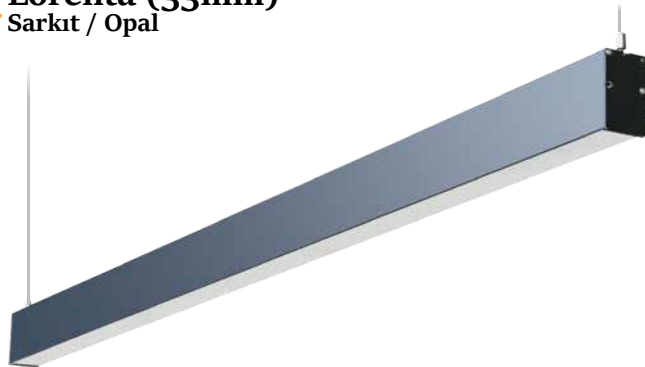

IP 40 3000K 4000K 6500K

Kod No	Özellikler	Koli Adedi	Fiyat
111384	16W 4000K 570mm	12	43,80 \$
111385	32W 4000K 1200mm	12	62,90 \$
111386	42W 4000K 1500mm	12	71,10 \$
111387	56W 4000K 1980mm	1	93,00 \$

## Pelsan Aplikler

### Da Vinci Krom



- Krom
- Gold
- Siyah

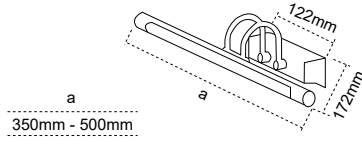

IP 40 4000K

Kod No	Özellikler	Koli Adedi	Fiyat
206276	6W 4000K 350mm	12	22,00 \$
206277	9W 4000K 500mm	12	28,70 \$

### Vogel



axbcm  
2x9W : 650x100x70  
20W : 1145x100x70

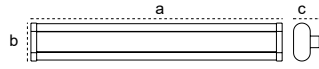

IP 20 4000K 6500K

Kod No	Özellikler	Koli Adedi	Fiyat
109541	20W 4000K LED	10	46,30 \$
109542	2x9W 6500K LED Tube Lambalı	10	21,00 \$

### Otto

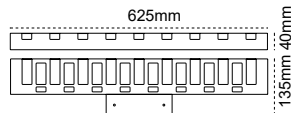

IP 20 4000K 6500K

Kod No	Özellikler	Koli Adedi	Fiyat
109539	10W 4000K LED	10	47,25 \$
109540	9W 6500K LED Tube Lambalı	10	32,25 \$

**Pio** 



Ø258mm



IP 40  ● 4000K ● 6500K

Kod No	Özellikler	Koli Adedi	Fiyat
206688	12W 4000K	9	8,90 \$
206677	12W 6500K	9	8,90 \$





Ø338mm



IP 40  ● 4000K ● 6500K

Kod No	Özellikler	Koli Adedi	Fiyat
206037	18W 4000K	10	10,20 \$
206913	18W 6500K	10	10,20 \$

**Pio** 



Ø387mm



IP 40  ● 4000K ● 6500K

Kod No	Özellikler	Koli Adedi	Fiyat
208411	28W 4000K	9	12,75 \$
208412	28W 6500K	9	12,75 \$



Ø338mm



IP 40  ● 4000K ● 6500K

Kod No	Özellikler	Koli Adedi	Fiyat
208572	18W 6500K Radar Sensörlü	10	20,10 \$

**Punto** 



Ø350



IP 40  ● 4000K ● 6500K

Kod No	Özellikler	Koli Adedi	Fiyat
111306	24W Yuvarlak 6500K RAL9006	10	29,20 \$
111307	24W Yuvarlak 6500K Radar Sensör RAL9006	10	45,70 \$

**Punto** 



350mm



IP 40  ● 4000K ● 6500K

Kod No	Özellikler	Koli Adedi	Fiyat
111309	24W Kare 6500K RAL9006	10	29,20 \$
111310	24W Kare 6500K Radar Sensör RAL9006	10	45,70 \$

**Picto** 



Ø350



IP 40  ● 4000K ● 6500K

Kod No	Özellikler	Koli Adedi	Fiyat
111312	24W Yuvarlak 6500K RAL9006	10	27,60 \$

**Picto** 



350mm



IP 40  ● 4000K ● 6500K

Kod No	Özellikler	Koli Adedi	Fiyat
111314	24W Kare 6500K RAL9006	10	27,60 \$

# Pelsan Downlight Armatürler



**Her Mekana Uygun Bir Tira Armatür Mutlaka Vardır!**



3 Farklı Boy  
9 Farklı Güç



**Tira G2 4" Alüminyum** Yeni Ürün

120mm  
30mm

IP 40 ⊕ ● 3000K ● 4000K ● 6500K

Kod No	Özellikler	Ø mm	Koli Adedi	Fiyat
114130	12W 4000K	120	20	19,40 \$

**Tira G2 6" Alüminyum** Yeni Ürün

152mm  
30mm

IP 40 ⊕ ● 3000K ● 4000K ● 6500K

Kod No	Özellikler	Ø mm	Koli Adedi	Fiyat
114133	24W 4000K	152	10	28,65 \$

**Rina Alüminyum 4" Sıva Üstü**

RAL 9005  
RAL 9006  
RAL 9016

130mm  
100mm

IP 40 ⊕ ● 3000K ● 4000K ● 6500K

Kod No	Özellikler	Koli Adedi	Fiyat
110599	12W 4000K	24	27,70 \$

**Rina Alüminyum 6" Sıva Üstü**

RAL 9005  
RAL 9006  
RAL 9016

175mm  
100mm

IP 40 ⊕ ● 3000K ● 4000K ● 6500K

Kod No	Özellikler	Koli Adedi	Fiyat
110600	24W 4000K	16	35,10 \$

## Tira Beyaz 4"



Kare Opsiyonu



Siyah Opsiyonu

Ø148mm

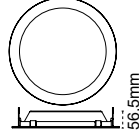

IP 40 ● 3000K ● 4000K ● 6500K

Kod No	Özellikler	Ø mm	Koli Adedi	Fiyat
106928	5W 4000K	132	20	23,90 \$
106934	7W 4000K	132	20	24,90 \$
106937	10W 4000K	132	20	25,80 \$

## Tira IP54 4"



Ø148mm

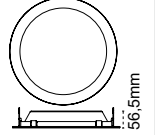

IP 54 ● 3000K ● 4000K ● 6500K

Kod No	Özellikler	Ø mm	Koli Adedi	Fiyat
107069	7W 4000K	132	20	30,20 \$
107072	10W 4000K	132	20	31,20 \$

## Tira Beyaz 6"



Kare Opsiyonu



Siyah Opsiyonu

Ø197mm

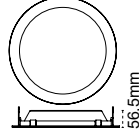

IP 40 ● 3000K ● 4000K ● 6500K

Kod No	Özellikler	Ø mm	Koli Adedi	Fiyat
106943	10W 4000K	185	15	26,80 \$
106950	15W 4000K	185	15	29,75 \$
106961	20W 4000K	185	15	33,71 \$

## Tira IP54 6"



Ø197mm

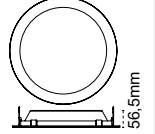

IP 54 ● 3000K ● 4000K ● 6500K

Kod No	Özellikler	Ø mm	Koli Adedi	Fiyat
107075	15W 4000K	220	10	36,70 \$
107078	20W 4000K	220	10	40,15 \$

## Tira Beyaz 8"



Kare Opsiyonu



Siyah Opsiyonu

Ø233mm

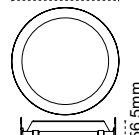

IP 40 ● 3000K ● 4000K ● 6500K

Kod No	Özellikler	Ø mm	Koli Adedi	Fiyat
106969	20W 4000K	220	10	41,70 \$
106977	25W 4000K	220	10	49,60 \$
106985	35W 4000K	220	10	57,50 \$

## Tira IP54 8"



Ø233mm

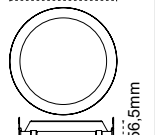

IP 54 ● 3000K ● 4000K ● 6500K

Kod No	Özellikler	Ø mm	Koli Adedi	Fiyat
107081	25W 4000K	220	10	55,95 \$
107084	35W 4000K	220	10	63,35 \$

# Pelsan Downlight Armatürler

## Dore



TSE Belgesi



Slim  
Tasarım



134 lm/W'a  
Varan Verimlilik



ENEC Belgesi  
Sürücü



+50.000h  
LED Ömrü

**Dore Sıva Altı**

**5 YIL GARANTİ**

**134lm/W'a Varan Verimlilik**

IP 40 ● 3000K ● 4000K ● 6500K

Kod No	Özellikler	Ø mm	Koli Adedi	Fiyat
110864	7W 4000K	105	30	11,50 \$
110865	10W 4000K	155	30	14,50 \$
110866	13W 4000K	155	30	16,50 \$
110867	18W 4000K	205	20	21,70 \$
110868	22W 4000K	205	20	22,95 \$

Øxhmm  
7W 120x45  
10-13W 170x45  
18-22W 225x45

**Dore Sıva Üstü**

**5 YIL GARANTİ**

**134lm/W'a Varan Verimlilik**

IP 40 ● 3000K ● 4000K ● 6500K

Kod No	Özellikler	Koli Adedi	Fiyat
111752	18W 4000K	30	25,75 \$
111755	22W 4000K	30	27,25 \$
111759	22W 4000K Acil Aydınlatma Kiti	24	52,20 \$

225mm  
55mm

## Opsiyon Farkları

Kod No	Özellikler	Koli Adedi	Fiyat
327764	Acil Aydınlatma Kiti (1 saat)	1	26,00\$
327251	Acil Aydınlatma Kiti (3 saat)	1	30,30\$

# Slim Backlight Downlight Armatürler **Pelsan**

Sirma

x2.09 kat

daha fazla ışık çıktısı

**Birebir**  
Değişim Garantisi



\*Sirma backlight, sıradan slim downlight armatürlere göre 2,09 kat daha fazla ışık çıktısı sunar.



**Slim**  
Tasarım



**Backlight**  
Işık Konforu



**Dahili**  
Sürücü



**Acil Kit**  
Uygulaması

## Sirma 6W



CE

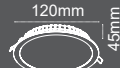

IP 40 ● 3000K ● 4000K ● 6500K

Kod No	Özellikler	Ø mm	Koli Adedi	Fiyat
110330	6W 3000K	105	20	4,30 \$
110331	6W 4000K	105	20	4,30 \$
110332	6W 6500K	105	20	4,30 \$

## Sirma 9W



CE

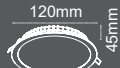

IP 40 ● 3000K ● 4000K ● 6500K

Kod No	Özellikler	Ø mm	Koli Adedi	Fiyat
110333	9W 3000K	105	20	5,70 \$
110334	9W 4000K	105	20	5,70 \$
110335	9W 6500K	105	20	5,70 \$

## Sirma 12W



CE



IP 40 ● 3000K ● 4000K ● 6500K

Kod No	Özellikler	Ø mm	Koli Adedi	Fiyat
110339	12W 3000K	155	15	6,80 \$
110340	12W 4000K	155	15	6,80 \$
110341	12W 6500K	155	15	6,80 \$

## Sirma 15W



CE

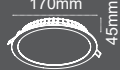

IP 40 ● 3000K ● 4000K ● 6500K

Kod No	Özellikler	Ø mm	Koli Adedi	Fiyat
110342	15W 3000K	155	15	8,50 \$
110343	15W 4000K	155	15	8,50 \$
110344	15W 6500K	155	15	8,50 \$

## Sirma 18W



CE



IP 40 ● 3000K ● 4000K ● 6500K

Kod No	Özellikler	Ø mm	Koli Adedi	Fiyat
110348	18W 3000K	205	10	9,80 \$
110349	18W 4000K	205	10	9,80 \$
110350	18W 6500K	205	10	9,80 \$

## Sirma Sıva Üstü



CE



IP 40 ● 3000K ● 4000K ● 6500K

Kod No	Özellikler	Koli Adedi	Fiyat
111748	18W 3000K	25	13,80 \$
111749	18W 4000K	25	13,80 \$
111750	18W 6500K	25	13,80 \$

## Opsiyon Farkları

Kod No	Özellikler	Koli Adedi	Fiyat
313117	Acil Aydınlatma Kiti (1 saat)	1	26,00 \$

# Pelsan Sensörlü Armatürler

Sense



## Işık Tam Zamanında Yansın!

- Time butonu ile lambanın ne kadar süreyle yanacağı
- Sens butonu ile lambanın ne kadar mesafeden hareketi algılayıp yanacağı ayarlanabilir.
- (-) işareti yükün yalnızca gece (+) işareti gündüz ve gece açık olacağını belirtir.
- Max.montaj yüksekliği 4.5m'di

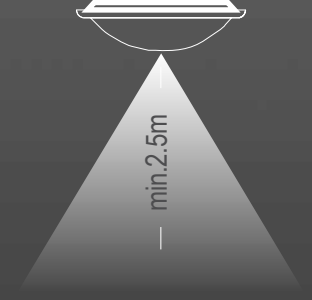

### Sensörlü (2xE27)



Sensör  
Duy



300mm

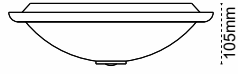

IP 20

Kod No	Özellikler	Koli Adedi	Fiyat
110695	2xE27	10	7,00 \$
110917	2XE27 Sensörlü	10	12,75 \$

### Acil Sensörlü (2xE27)



Sensör  
Acil  
Duy



300mm

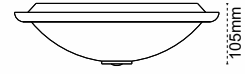

IP 20

Kod No	Özellikler	Koli Adedi	Fiyat
110697	2xE27 Sensörlü + Acil Ayd.	10	15,70 \$

### LED'li Sensörlü



Sensör  
LED



300mm



IP 20

Kod No	Özellikler	Koli Adedi	Fiyat
110696	8W LED 6500K Sensörlü	10	13,60 \$

### Acil LED'li Sensörlü



Sensör  
Acil  
LED



300mm



IP 20

Kod No	Özellikler	Koli Adedi	Fiyat
104369	8W LED 6500K Sens.+ Acil Ayd.	10	19,90 \$

### Sensörlü 30x30 Sıva Üstü



Sensör  
Acil



55mm

IP 40

Kod No	Özellikler	Koli Adedi	Fiyat
108780	12W 6500K Radar Sens.	5	40,50 \$
109086	12W 6500K Radar Sens. + Acil Ayd. Kit	5	66,50 \$

### Işıközü Sensörlü

220mm



280mm

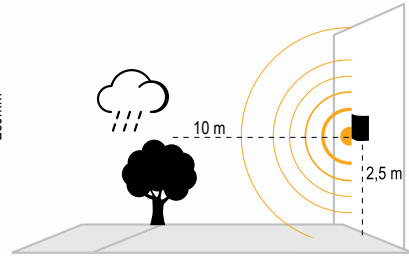

Alüminyum  
Enjeksiyon

IP 44

Kod No	Özellikler	Koli Adedi	Fiyat
109297	E27 Duyulu Sensörlü	8	27,20 \$





**Vidasız Çerçeve ile  
Mükemmel Görünüm**



**Yeni  
Havana**



**Daha Kolay Montaj**



**Kitli + Radar Sensörlü**



**IP66 Su ve Toz Almaz!**

**Havana G2 - E27 Duyulu  
IP66**

- BEYAZ
- GRI
- SİYAH

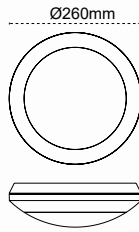
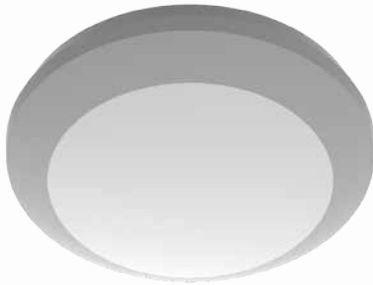

IP 66

Kod No	Özellikler	Koli Adedi	Fiyat
111193	E27	8	16,50 \$
111194	2XE27	8	17,60 \$
111220	E27 Sensör	8	30,50 \$
111223	2XE27 Sensör	8	31,60 \$



**Havana G2 - LED - ENEC Driver  
IP66**

- BEYAZ
- GRI
- SİYAH

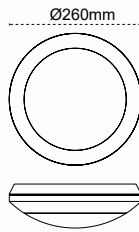
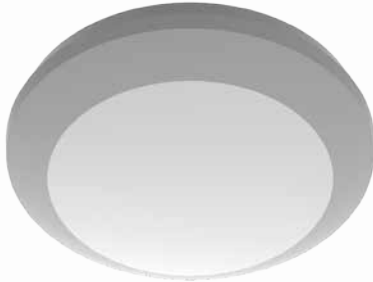

IP 66

Kod No	Özellikler	Koli Adedi	Fiyat
111226	15W 6500K	8	29,60 \$
111236	15W 6500K Sensör	8	43,60 \$
111245	15W 6500K Acil Ayd Kit	8	55,60 \$
111260	15W 6500K Sensör + Acil Ayd Kit	8	69,60 \$



**Havana G2 - LED - Integrated Driver  
IP66**

- BEYAZ
- GRI
- SİYAH

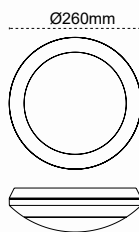
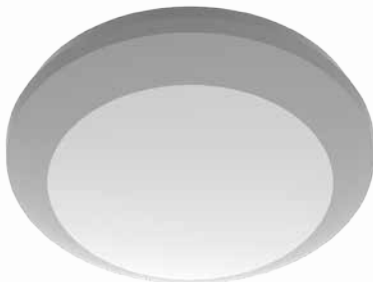

IP 66

Kod No	Özellikler	Koli Adedi	Fiyat
111692	18W 6500K	8	23,80 \$
111701	18W 6500K Sensör	8	37,80 \$



# Pelsan Sensörler

## 360° Hareket Sensörü



6 m

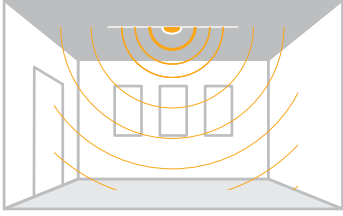

2,5 m

IP 20

Kod No	Özellikler	Koli Adedi	Fiyat
314720	360 Derece Hareket Sensörü	50	9,00 \$

## Varlık Sensörü



20 m

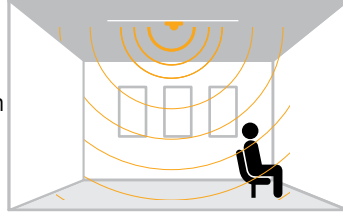

2,5 m

Ortamdaki kişiye duyarlı olarak aydınlatma kontrolü sağlar.

IP 20

Kod No	Özellikler	Koli Adedi	Fiyat
314733	Varlık Sensörü	50	22,80 \$

## Radar Sensör



15 m

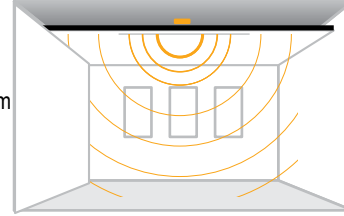

3,5 m

Sıva altı, gizli, armatür içi ve dışı uygulamalarda en iyi çözüm.

IP 20

Kod No	Özellikler	Koli Adedi	Fiyat
314735	IP65 Sensör Kutusu	50	10,40 \$
314725	Radar Sensör	100	14,00 \$

## Sıva Altı Tavan Sensör



8 m

60mm

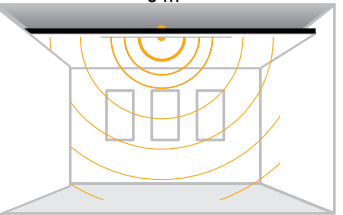

3,5 m

Zaman, Lux ve mesafe ayarlama özelliği ile sıva altı uygulamalar için ideal çözüm.

IP 20

Kod No	Özellikler	Koli Adedi	Fiyat
314726	Sıva Altı Tavan Sensör	50	10,20 \$

## Sıva Altı Radar Sensör Yeni Ürün



6 m

66mm

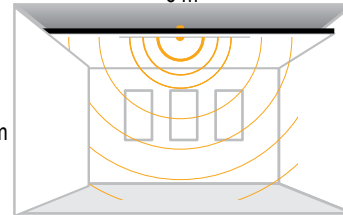

4 m

Zaman, Lux ve mesafe ayarlama özelliği ile sıva altı uygulamalar için ideal çözüm.

IP 20

Kod No	Özellikler	Koli Adedi	Fiyat
326838	Sıva Altı Radar Sensör	50	14,00 \$

## Sıva Üstü Radar Sensör Yeni Ürün



8 m

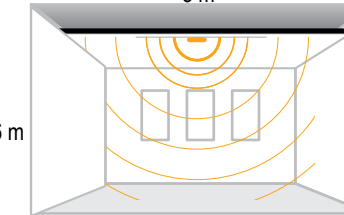

6 m

Zaman, Lux ve mesafe ayarlama özelliği ile sıva üstü uygulamalar için ideal çözüm.

IP 20

Kod No	Özellikler	Koli Adedi	Fiyat
326839	Sıva Üstü Radar Sensör	50	14,75 \$

## Mini Hareket Sensörü



6 m

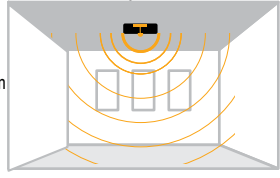

2,5 m

Uygulama alanında karşılaşılan mekanik yerleşim sorunlarını gidermek için pratik kullanım sağlar.

IP 20

Kod No	Özellikler	Koli Adedi	Fiyat
314732	Mini Hareket Sensörü	100	8,40 \$

## Yüksek Tavan Sensörü



10 m

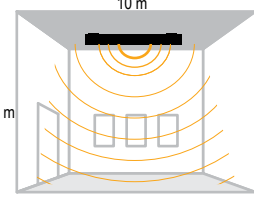

15 m

4-15 mt arası yüksekliklerde hassas algılama yapan yüksek tavan sensörü ile Lux, mesafe ve zaman ayarı yapılabilir.

IP 20

Kod No	Özellikler	Koli Adedi	Fiyat
314730	Yüksek Tavan Sensörü	50	32,40 \$

## 180° Hareket Sensörü



12 m

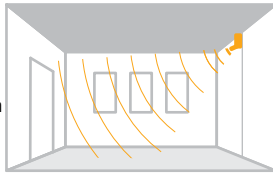

2,5 m

IP 20

Kod No	Özellikler	Koli Adedi	Fiyat
314717	180° Hareket Sensörü	50	8,40 \$

## Fotosel



Gece gündüz farkını algılayarak dış mekan aydınlatmalarında kontrol sağlar.

IP 20

Kod No	Özellikler	Koli Adedi	Fiyat
314738	Fotosel	100	5,40 \$

# Acil Durumlarda Pelsan Güvencesi

Yeni

IP40 / IP65  
Metal Spot Emergency



Oynar Başlık



Anahtarlı, Test Butonlu



Şarj, Deşarj Göstergeli



6 Saat Deşarj Süresi



Taşınabilir, Asılabilir



IP40 / IP65 Opsiyonel



## Acil Aydınlatma / Yönlendirme Armatürleri



IP65 Exproof  
Acil Aydınlatma Armatürü



Acil Yönlendirme  
Armatürü



Acil Yönlendirme  
Armatürü



IP65 Acil  
Aydınlatma/Yönlendirme  
Armatürü

# Pelsan Acil Aydınlatma Armatürleri



-  Oynar Başlık
-  Anahtarlı, Test Butonlu
-  Şarj, Deşarj Göstergeli
-  6 Saat Deşarj Süresi
-  Taşınabilir, Asılabilir



## IP65 Emergency Spot

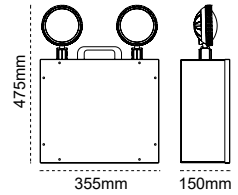

IP 65  4000K  6500K

Kod No	Özellikler	Koli Adedi	Fiyat
110679	2x10W 6 Saat 4000K	4	166,20 \$

## Metal Kasa Emergency Spot



2x5W



2x10W

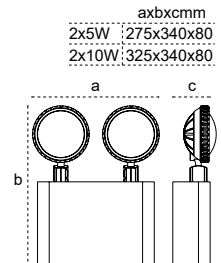

IP 40  4000K  6500K

Kod No	Özellikler	Koli Adedi	Fiyat
109781	2x5W 6 Saat 4000K	4	75,00 \$

Kod No	Özellikler	Koli Adedi	Fiyat
109780	2x10W 6 Saat 4000K	4	130,00 \$

IP 40  4000K  6500K

Kod No	Özellikler	Koli Adedi	Fiyat
109780	2x10W 6 Saat 4000K	4	130,00 \$

## Emergency Spot



2x3W

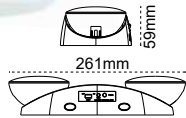

2x5W

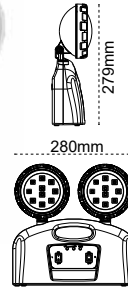

2x10W

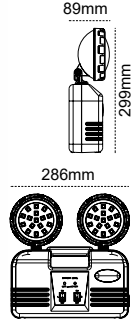

IP 40 

Kod No	Özellikler	Koli Adedi	Fiyat
203911	2x3W LEDli 6 Saat	10	43,00 \$

Kod No	Özellikler	Koli Adedi	Fiyat
203913	2x5W LEDli 4 Saat	8	66,50 \$

Kod No	Özellikler	Koli Adedi	Fiyat
203907	2x10W LEDli 4 Saat	8	107,00 \$

# Acil Aydınlatma ve Yönlendirme Armatürleri **Pelsan**



 5 W-10W, 3 Saat Deşarj Süresi

 ENEC Belgeli Sürücü

 IP65, Toz ve Su Almaz!

 AC/DC ve DC Çalışma Modu

 Sıva Altı, Sıva Üstü Montaj

## Geniş Kullanım Alanı

Merdivenler | Koridorlar | Yangın Dolap Üstleri | Tuvalet Girişleri | Elektrik Pano Üstleri



Dört Farklı Yönlendirme Etiketli Hedyeli



Ürün Tanıtım Videosu

### IP65 Acil Aydınlatma ve Yönlendirme Armatürü Ausled (3 Saat)

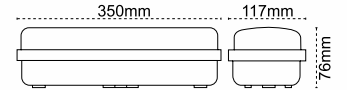

IP 65  4000K  6500K

Kod No	Özellikler	Koli Adedi	Fiyat
108390	5W 6500K Sıva Üstü AC/DC 3 Saat	12	45,60 \$
315895	Sıva Altı Yaylı (ikili)	1	2,50 \$

IP 65  4000K  6500K

Kod No	Özellikler	Koli Adedi	Fiyat
115138	10W 6500K Sıva Üstü AC	12	23,70 \$
115140	3W 6500K Sıva Üstü DC 3 Saat	12	42,70 \$
110667	10W 6500K Sıva Üstü AC/DC 3 Saat	12	49,70 \$

### LED Ex-Proof Acil Ayd. Ausled IP65

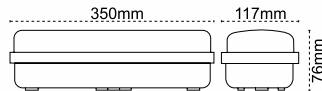

IP 65 

Kod No	Özellikler	Koli Adedi	Fiyat
109710	15W 6500K	12	101,60 \$
323993	Ex-Proof Duvar Bağlantı Aparatı (ikili)	1	1,25 \$

### LED Ex-Proof Acil Ayd. Yönli. Rausled IP65

**Yeni Ürün**

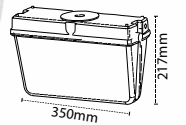

IP 54  6500K

Kod No	Özellikler	Koli Adedi	Fiyat
111683	15W 6500K Sıva Üstü	12	101,60 \$

# Pelsan Acil Aydınlatma ve Yönlendirme Armatürleri

**Çift Yön**  
Vialed (3 Saat)

sabit etiketli



310mm 110mm  
205mm

IP 20

Kod No	Özellikler	Koli Adedi	Fiyat
200965	Çift Yön 3W	20	27,80 \$

**Çift Yön**  
Vialed (3 Saat)

sabit etiketli



310mm 110mm  
205mm

IP 20

Kod No	Özellikler	Koli Adedi	Fiyat
200981	Çift Yön 3W	20	27,80 \$

**Çift Yön**  
Vialed (3 Saat)

sabit etiketli



310mm 110mm  
205mm

IP 20

Kod No	Özellikler	Koli Adedi	Fiyat
200963	Çift Yön 3W	20	27,80 \$

**Tek / Çift Yön**  
Vialed (3 Saat)

sabit etiketli



310mm 110mm  
205mm

IP 20

Kod No	Özellikler	Koli Adedi	Fiyat
200944	Tek Yön 3W	20	27,80 \$
201013	Çift Yön 3W	20	27,80 \$

**Çift Yön**  
Vialed (3 Saat)

sabit etiketli



310mm 110mm  
205mm

IP 20

Kod No	Özellikler	Koli Adedi	Fiyat
205265	Çift Yön 3W	20	27,80 \$

**Çift Yön**  
Vialed (3 Saat)

sabit etiketli



310mm 110mm  
205mm

IP 20

Kod No	Özellikler	Koli Adedi	Fiyat
200946	Çift Yön 3W	20	27,80 \$

**Acil Yönlendirme**  
Armatürü  
Vialed (3 Saat)

Sıva Altı



310mm 110mm  
205mm

IP 20

Kod No	Özellikler	Koli Adedi	Fiyat
201064	S.A. Tek Yön 3W	20	27,80 \$
201110	S.A. Çift Yön 3W	20	27,80 \$

**Acil Yönlendirme**  
Armatürü  
Vialed (3 Saat)

Sarkıt



310mm 110mm  
205mm

IP 20 Sarkıt

Kod No	Özellikler	Koli Adedi	Fiyat
201136	Sarkıt Tek Yön 3W	10	27,80 \$
201165	Sarkıt Çift Yön 3W	10	27,80 \$

**IP65 Acil Yönlendirme**  
Armatürü  
Rausled (3 Saat)

ACIL YÖNLENDİRME ARMATÜRÜ  
IP65



4 Farklı Yön Etiketli



350mm 217mm

IP 20

Kod No	Özellikler	Koli Adedi	Fiyat
113621	3W 6500K Sıva Üstü	10	56,00 \$

# Acil Aydınlatma ve Yönlendirme Armatürleri **Pelsan**

**Çift Yön**  
Exiled (3 Saat)

sabit etiketli

360mm 24mm  
150mm

IP 20

Kod No	Özellikler	Koli Adedi	Fiyat
203888	Çift Yön 3W	20	10,20 \$

**Çift Yön**  
Exiled (3 Saat)

sabit etiketli

360mm 24mm  
150mm

IP 20

Kod No	Özellikler	Koli Adedi	Fiyat
203889	Çift Yön 3W	20	10,20 \$

**Çift Yön**  
Exiled (3 Saat)

sabit etiketli

360mm 24mm  
150mm

IP 20

Kod No	Özellikler	Koli Adedi	Fiyat
203887	Çift Yön 3W	20	10,20 \$

**Tek / Çift Yön**  
Exiled (3 Saat)

sabit etiketli

360mm 24mm  
150mm

IP 20

Kod No	Özellikler	Koli Adedi	Fiyat
203891	Tek Yön 3W	20	10,20 \$
203885	Çift Yön 3W	20	10,20 \$

**Çift Yön**  
Exiled (3 Saat)

sabit etiketli

360mm 24mm  
150mm

IP 20

Kod No	Özellikler	Koli Adedi	Fiyat
203890	Çift Yön 3W	20	10,20 \$

**Çift Yön**  
Exiled (3 Saat)

sabit etiketli

360mm 24mm  
150mm

IP 20

Kod No	Özellikler	Koli Adedi	Fiyat
205688	Çift Yön 3W	20	10,20 \$

**İşıldaklar**

203mm 55mm 29mm  
342mm 55mm 29mm  
482mm 55mm 29mm

IP 40

Kod No	Özellikler	Koli Adedi	Fiyat
204619	30 LED'li İşıldak	40	8,80 \$
204620	40-60 LED'li İşıldak	24	15,20 \$
204623	90 LED'li İşıldak	20	24,80 \$

**Solar İşıldak**

Solar  
220Vac

141.4mm  
64.4mm  
45.4mm

IP 20

Kod No	Özellikler	Koli Adedi	Fiyat
206489	30 LED'li İşıldak	20	14,80 \$

**Acil Aydınlatma Kiti**

IP 20

Kod No	Özellikler	Koli Adedi	Fiyat
327251	12-110V LED Konvertör Kit (1saat)	50	26,00 \$
327764	12-110V LED Konvertör Kit (3saat)	50	30,30 \$

**220V Acil Aydınlatma Kiti**

IP 20

Kod No	Özellikler	Koli Adedi	Fiyat
313117	3-20W LED Tube Konvertör Kit	25	26,00 \$

# Pelsan Süpermarket Armatürleri

## Fixline Lineer LED Armatür

## Monoline Lineer LED Armatür

## Fixline Lineer LED Armatür



### Kolay Lineer Bağlantı

T5 Floresana göre  
%60'a varan tasarruf sağlar.

Kolay lineer bağlantı

ENECE belgeli sürücü

T5'e göre 2,5 kat  
uzun ömürlüdür.

IP 20 3000K 4000K 6500K

Kod No	Özellikler	Koli Adedi	Fiyat
113238	35W 6500K 120cm Opal Difüzör	6	112,50 \$
113239	35W 6500K 120cm Opal Difüzör Lineer Bağlantı	6	117,50 \$



## Monoline Lineer LED Armatür



### Kolay Lineer Bağlantı

T5 Floresana göre  
%60'a varan tasarruf sağlar.

Kolay lineer bağlantı

ENECE belgeli sürücü

T5'e göre 2,5 kat  
uzun ömürlüdür.

IP 20 3000K 4000K 6500K

Kod No	Özellikler	Koli Adedi	Fiyat
109564	28W 6500K 111cm Opal Difüzör	6	64,75 \$
109566	35W 6500K 150cm Opal Difüzör	4	72,50 \$



120  
lm/W  
verimlilik

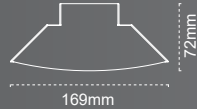



## Etanj Duyulu Sac Bant LED Tube Uygun - Impera



### Tozlu ve Titreşimli Alanlar İçin!

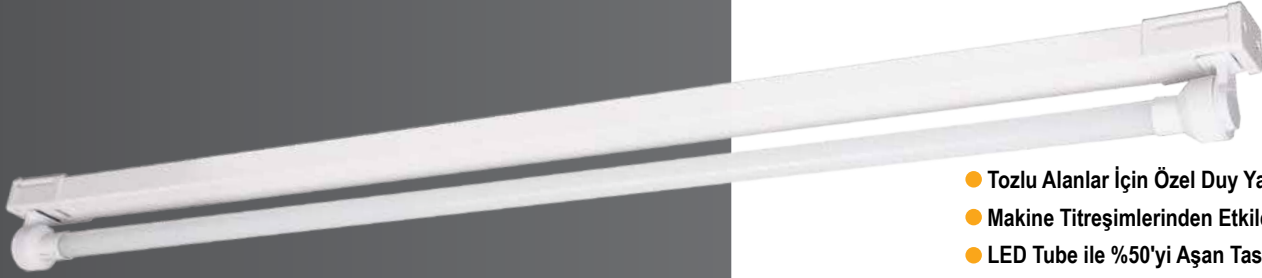

- Tozlu Alanlar İçin Özel Duy Yapısı!
- Makine Titreşimlerinden Etkilenmez!
- LED Tube ile %50'yi Aşan Tasarruf!

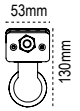

IP 54

Kod No	Özellikler	Koli Adedi	Fiyat
111276	Tekli 60cm	12	10,60 \$
111618	Tekli 120cm	12	12,20 \$
111620	Tekli 150cm	12	15,30 \$
111277	İkili 60cm	12	13,90 \$
111619	İkili 120cm	12	15,80 \$
111275	İkili 150cm	12	18,80 \$

## Etanj Duyulu Polyester Bant LED Tube Uygun



### Tozlu ve Nemli Alanlar İçin!



- IP65 Toz ve Su Almaz!
- Anti-Korozyon Gövde!
- LED Tube ile %50'yi Aşan Tasarruf!

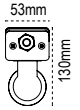

IP 65

Kod No	Özellikler	Koli Adedi	Fiyat
103200	Polyester Tekli 120cm	6	22,30 \$
103261	Polyester Tekli 150cm	6	24,20 \$
103210	Polyester İkili 120cm	6	25,30 \$
103268	Polyester İkili 150cm	6	27,20 \$

## LED Tube TMS



### Hem Tasarruflu Hem Ekonomik!



- En Ekonomik Bant Armatür!
- LED Tube ile %50'yi Aşan Tasarruf!
- Kolay ve Hızlı Kurulum!

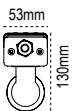

IP 20

Kod No	Özellikler	Koli Adedi	Fiyat
111279	TMS Tekli 60cm	12	6,50 \$
111621	TMS Tekli 120cm	12	7,50 \$
111280	TMS İkili 60cm	12	9,75 \$
111278	TMS İkili 120cm	12	10,75 \$

## Pelsan Bant Armatürler

Linea IP65



LED Bant Armatür  
Linea IP65

Yeni Ürün

CE

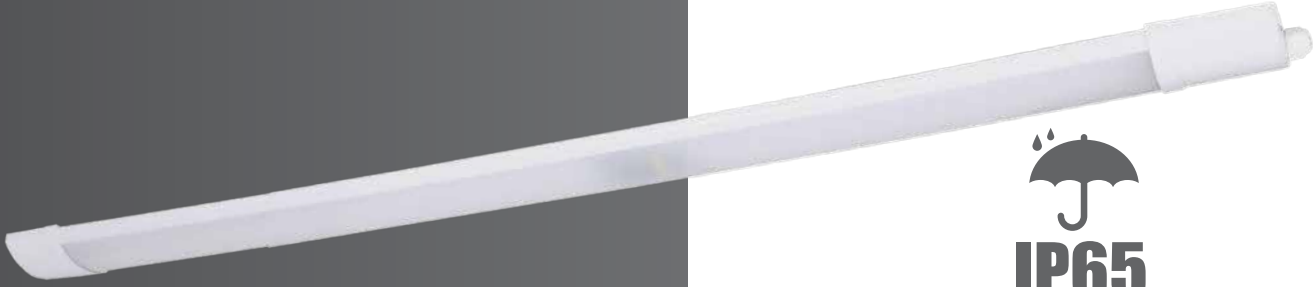

IP65

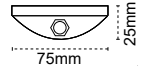

IP 65 4000K 6500K

Kod No	Özellikler
113654	36W 6500K 110cm

Koli Adedi	Fiyat
6	15,70 \$

LED Bant Armatür  
Linea IP40

CE

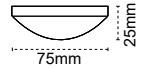
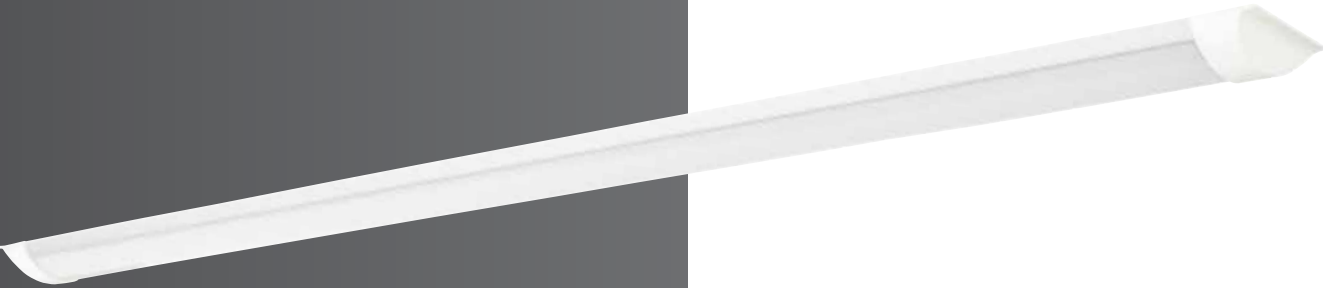

IP 40 4000K 6500K

Kod No	Özellikler
113653	36W 4000K 110cm
113652	36W 6500K 110cm

Koli Adedi	Fiyat
6	10,40 \$
6	10,40 \$

# Türkiye'de TEK! GRP Gövde Etanj



Yüksek mekanik dayanım



UV ışınlarından etkilenmez



Anti korozyon, paslanmaz



Kimyasal dayanımı yüksek



850°C kızaran tel testinden geçer

## LED Etanj Largo

5 Yıl  
Garanti

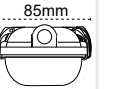

IP 65 3000K 4000K 6500K

Kod No	Özellikler	Koli Adedi	Fiyat
109150	20W 6500K 60cm	6	24,00 \$
109151	36W 6500K 120cm	6	30,40 \$
109153	42W 6500K 150cm	6	42,50 \$

## Yüksek Güçlü Etanj Largo LED MAX

75W  
128lm/W



IP 65 3000K 4000K 6500K

Kod No	Özellikler	Koli Adedi	Fiyat
113888	50W 6500K 120cm	6	68,50 \$
113230	75W 6500K 120cm	6	73,50 \$

# Pelsan Özel Etanj Armatürler

## Otopark Fonksiyonlu LED Etanj Largo LED



**Maksimum  
Tasarruf  
Sağlar**

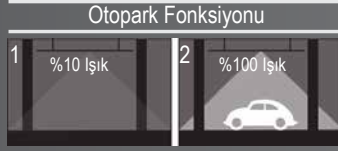

IP 65 ● 3000K ● 4000K ● 6500K

Kod No	Özellikler	Koli Adedi	Fiyat
113489	36W 6500K 120cm Otopark Fonksiyonlu	6	113,00 \$



## Soğuk Hava Deposu için LED Etanj Largo LED Frozen



**-40°C'ye Kadar Çalışır.**

Soğuk hava depoları ve donuk ürün depoları kullanımı için uygundur.

IP 65 ● 3000K ● 4000K ● 6500K

Kod No	Özellikler	Koli Adedi	Fiyat
105871	21W 6500K 60cm (-25°C)	6	191,30 \$
105884	42W 6500K 120cm (-40°C)	6	213,80 \$
105894	63W 6500K 150cm (-40°C)	6	225,10 \$



## Atex Belgeli Ex-Proof Etanj Largo Ex-Proof

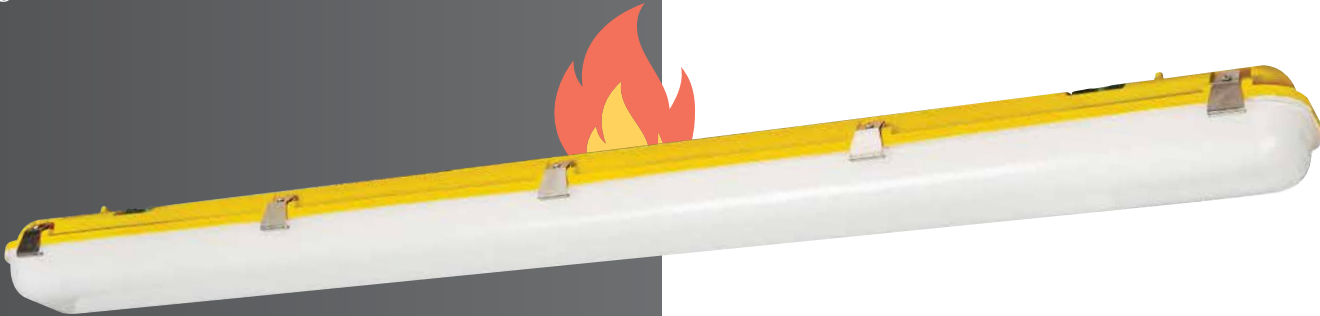

- **Gaz Patlama Koruması: Zone 2**
  - II 3G Ex nR IIC T6 Gc
- **Toz Patlama Koruması: Zone 22**
  - II 3D Ex tc IIIC (T80 C) Dc

IP 65 ● 3000K ● 4000K ● 6500K

Kod No	Özellikler	Koli Adedi	Fiyat
108458	25W LED 6500K Opal 60cm	6	174,75 \$
108459	45W LED 6500K Opal 120cm	6	187,50 \$
108297	2x18W T8 Şeffaf 60cm	6	110,50 \$
108298	2x36W T8 Şeffaf 120cm	6	116,25 \$



## Prota G3

Yeni Ürün



5 YIL GARANTİ



IP65

Alümiyum  
Gövde

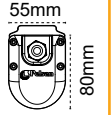

IP 65 3000K 4000K 6500K

Kod No	Özellikler	Koli Adedi	Fiyat
115014	18W 6500K 55cm	6	29,75 \$
115016	23W 6500K 80cm	6	37,90 \$
115018	33W 6500K 105 cm	6	46,80 \$
115020	43W 6500K 130cm	6	54,45 \$

## Solida G2



5 YIL GARANTİ



IP65

Alümiyum  
Gövde

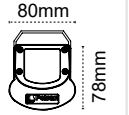

IP 65 3000K 4000K 6500K

Kod No	Özellikler	Koli Adedi	Fiyat
111052	19W 6500K 60cm	6	65,00 \$
111058	30W 6500K 90cm	6	67,00 \$
111059	34W 6500K 90cm	6	70,00 \$
111061	33W 6500K 120cm	6	89,00 \$
111062	40W 6500K 120cm	6	95,50 \$
111063	40W 6500K 150cm	4	106,50 \$
111064	44W 6500K 150cm	4	115,00 \$

## Inovaled IP66



IP66

Alümiyum  
Gövde

Temperli  
Cam

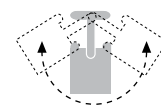

IP 66 3000K 4000K 6500K

Kod No	Özellikler	Koli Adedi	Fiyat
113454	19W 6500K 60 cm	4	50,50 \$
113457	26W 6500K 90 cm	4	77,00 \$
113460	34W 6500K 120 cm	6	92,50 \$
326217	Açı ayarlı montaj aparatı (2'li)		5,25 \$

## Pelsan PC Etanj Armatürler

5  
YIL  
GARANTİ

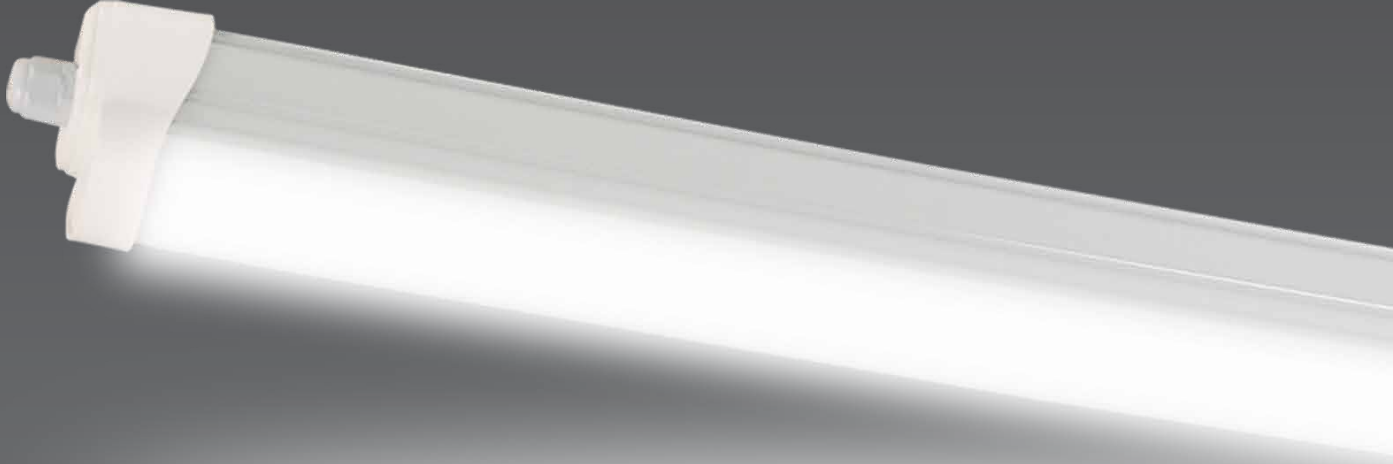

Kurum  
Şartnamelerine  
Uygun



Kolay  
Montaj



Through  
Wiring



Kolay  
Elektriksel  
Montaj



IP65  
Su ve Toz  
Almaz

### Folta

Yeni Ürün



IP 65 4000K 6500K

Kod No	Özellikler	Koli Adedi	Fiyat
115005	18W 6500K 55cm	6	26,80 \$
115007	23W 6500K 80cm	6	27,70 \$
115009	33W 6500K 105cm	4	30,50 \$
115011	43W 6500K 130cm	4	42,50 \$

### Fontana

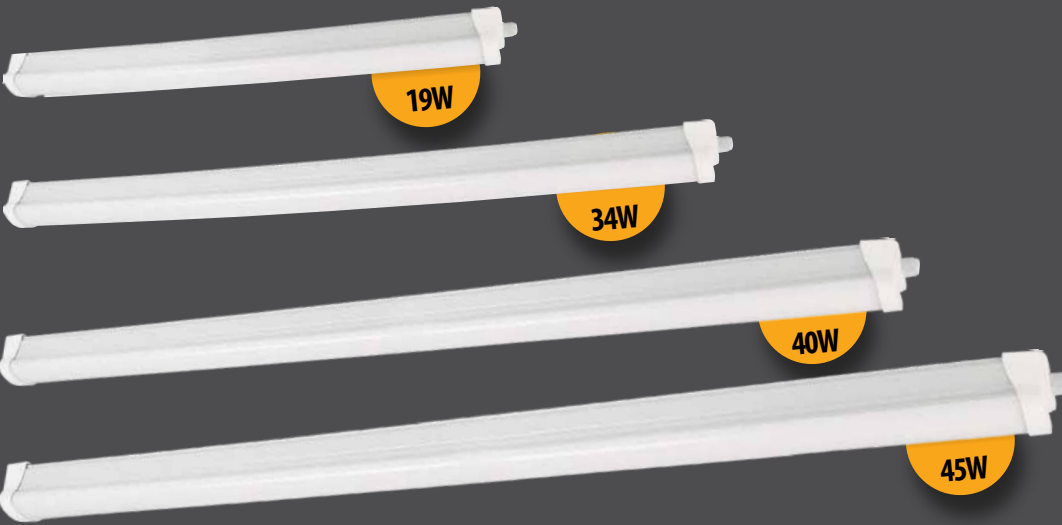

IP 65 4000K 6500K

Kod No	Özellikler	Koli Adedi	Fiyat	Kod No	Özellikler	Koli Adedi	Fiyat
111078	19W 6500K 60cm	6	30,45 \$	111084	33W 6500K 120cm	6	34,70 \$
111079	26W 6500K 90cm	6	31,50 \$	111085	40W 6500K 120cm	6	41,75 \$
111082	30W 6500K 90cm	6	32,50 \$	111086	40W 6500K 150cm	4	48,30 \$
111083	34W 6500K 90cm	6	33,70 \$	111087	44W 6500K 150cm	4	52,50 \$

## Largo LED Tube x1



**x1**  
LED Tube

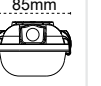

IP 65  4000K  6500K

Kod No	Özellikler	Koli Adedi	Fiyat
102669	LED Tube Tekli 60cm	6	13,50 \$
102713	LED Tube Tekli 120cm	6	17,20 \$
102867	LED Tube Tekli 150cm	6	33,80 \$

## Largo LED Tube x2



**x2**  
LED Tube

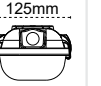

IP 65  4000K  6500K

Kod No	Özellikler	Koli Adedi	Fiyat
102687	LED Tube İkili 60cm	6	14,10 \$
102744	LED Tube İkili 120cm	6	19,80 \$
102878	LED Tube İkili 150cm	6	35,20 \$

## LED Tube Pro



 130lm/W

 ABS Gövde

Kod No	Özellikler	Koli Adedi	Fiyat
323524	22W 6500K 150cm 135 lm/W	25	18,50 \$

## LED Tube Cam Gövde



  
Tek Taraftan  
Bağlantı

 Cam  
Gövde

 Kolay  
Kurulum

 60 / 120 / 150 cm  
Boy Seçeneği

Kod No	Özellikler	Koli Adedi	Fiyat
314663	9W 4000K 60cm	25	4,45 \$
314664	9W 6500K 60cm	25	4,45 \$
314666	18W 4000K 120cm	25	4,80 \$
314665	18W 6500K 120cm	25	4,80 \$

Kod No	Özellikler	Koli Adedi	Fiyat
314669	22W 4000K 150cm	25	9,70 \$
314668	22W 6500K 150cm	25	9,70 \$

## Pelsan Benzinlik Armatürleri

### Lenta

IP65 LED Kanopi Armatür



Sıva Üstü Farkı  
19.00\$

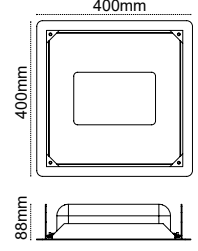

IP 65

Kod No	Özellikler	
110507	100W	5000K

Koli Adedi	Fiyat
1	101,60 \$

### Okta

IP65 LED Kanopi Armatür



80 W  
140 lm/W

Lens Farkı  
29.00\$



ENEC Belgesi Sürücü



+50.000 Saat Ömür



IP65, Toz ve Su Almaz!

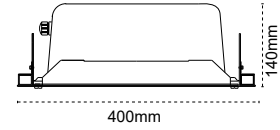

IP 65

4000K 6500K

Kod No	Özellikler	
106627	80W	6500K
110173	100W	6500K

Koli Adedi	Fiyat
1	129,30 \$
1	166,20 \$

### Piroliz

IP65 LED Kanopi Armatür



ENEC Belgesi Sürücü



+50.000 Saat Ömür



IP65, Alüminyum Enjeksiyon Gövde

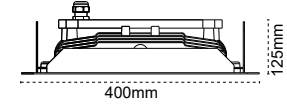

IP 65

4000K 6500K

Kod No	Özellikler	
109937	75W	6500K
109938	100W	6500K
109939	125W	6500K

Koli Adedi	Fiyat
1	333,00 \$
1	333,00 \$
1	333,00 \$

### Piroliz Ex-Proof

IP66 LED Kanopi Armatür



- Gaz Patlama Koruması: II 3G Ex nR IIC T5 Gc
- Toz Patlama Koruması: II 3D Ex tc IIIC (T95 C) Dc

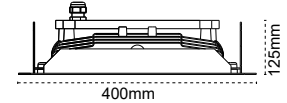

IP 66

4000K 6500K

Kod No	Özellikler	
111376	Piroliz Ex 50W	6500K
111375	Piroliz Ex 75W	6500K
111374	Piroliz Ex 100W	6500K
111382	Piroliz Ex 125W	6500K
111373	Piroliz Ex 150W	6500K
111056	Piroliz Ex 200W	6500K

Koli Adedi	Fiyat
1	330,50 \$
1	372,25 \$
1	414,75 \$
1	458,25 \$
1	500,25 \$
1	552,50 \$





# Sabit Gerilim 24V Armatürler **Pelsan**

**24V DC 100W**  
LED Projektör



**24V DC**

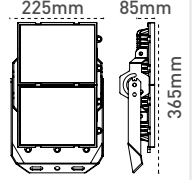

IP 66

Kod No	Özellikler	Koli Adedi	Fiyat
110506	100W 5700K	1	110,00 \$

**24V DC 50W**  
LED Projektör



**24V DC**

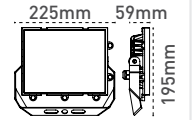

IP 66

Kod No	Özellikler	Koli Adedi	Fiyat
110171	50W 5700K	1	59,00 \$

**24V DC 42W**  
LED Etanj / 120 cm



**24V DC**

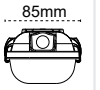

IP 65

Kod No	Özellikler	Koli Adedi	Fiyat
110114	42W 6500K 120cm	6	54,00 \$

**24V DC 21W**  
LED Etanj / 60cm



**24V DC**

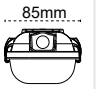

IP 65

Kod No	Özellikler	Koli Adedi	Fiyat
110119	21W 6500K 60cm	6	51,00 \$

# Pelsan Yüksek Tavan Armatürleri

Cronto IP66



**En Zor Koşullarda 7/24 Yüksek Performans**

Driver  
Üstünlükleri



ENEC Belgeli  
Sürücü



100.000 h  
Driver Ömrü



10kV Dahili  
Parafudr



-40°C +55°C



IP67



100-277Vac  
Gerilim Dalgalanmalarından Etkilenmez

Cronto IP66 150W-200W



Lens Seçeneği



IP 66 4000K 6500K

Kod No	Özellikler	Koli Adedi	Fiyat
111333	150W 5700K 90°	1	292,00 \$
111334	200W 5700K 90°	1	308,00 \$

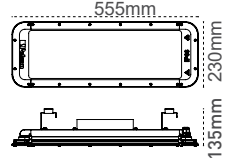

Cronto IP66 250W-300W



Lens Seçeneği

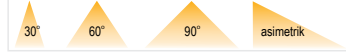

IP 66 4000K 6500K

Kod No	Özellikler	Koli Adedi	Fiyat
111331	250W 5700K 90°	1	385,50 \$
111332	300W 5700K 90°	1	385,50 \$

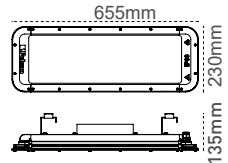

Cronto IP66 350W-400W



Lens Seçeneği

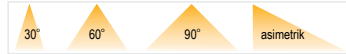

IP 66 4000K 6500K

Kod No	Özellikler	Koli Adedi	Fiyat
111335	350W 5700K 90°	1	513,50 \$
111336	400W 5700K 90°	1	513,50 \$

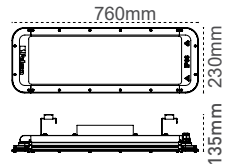

## Etna G2



**7/24 Çalışan**

**Endüstriyel Tesislerde**

**Ultra Performans!**

**5**

**5 Yıl Garanti**



**ENEC Belgeli Sürücü**



**72.000 Saat LED Çip Ömrü**



**150 lm/W'a Varan Verimlilik Faktörü**

IP 65 4000K 6500K

IP 65 4000K 6500K

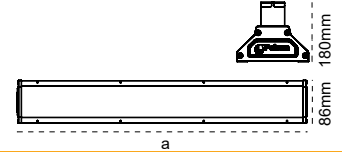

Kod No	Özellikler	Dar Açısı	a (mm)	Koli Adedi	Fiyat	Kod No	Özellikler	Geniş Açısı	a (mm)	Koli Adedi	Fiyat
111273	100W 6500K	Dar Açısı	60cm	1	134,80 \$	111272	100W 6500K	Geniş Açısı	60cm	1	134,80 \$
111271	150W 6500K	Dar Açısı	90cm	1	188,40 \$	111270	150W 6500K	Geniş Açısı	90cm	1	188,40 \$
111269	200W 6500K	Dar Açısı	120cm	1	279,10 \$	111259	200W 6500K	Geniş Açısı	120cm	1	279,10 \$
111258	250W 6500K	Dar Açısı	150cm	1	328,30 \$	111257	250W 6500K	Geniş Açısı	150cm	1	328,30 \$
111256	300W 6500K	Dar Açısı	150cm	1	328,30 \$	111255	300W 6500K	Geniş Açısı	150cm	1	328,30 \$

## Etna G2 Heavy Industry



**Ağır Sanayi**

**Tesisleri için**

**Ultra Performans!**

**+70° C'ye Kadar Çalışır.**

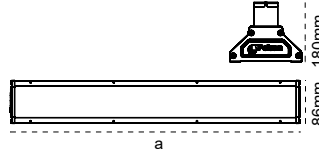

IP 65 4000K 6500K



Duvar Bağlantı Aparatı

Kod No	Özellikler	a (mm)	Koli Adedi	Fiyat
113466	100W 6500K Dar Açısı	1200	1	287,50 \$
113467	200W 6500K Dar Açısı	1500	1	374,50 \$

## Etna G2 Food



**Gıda**

**Tesisleri için**

**Ultra Performans!**

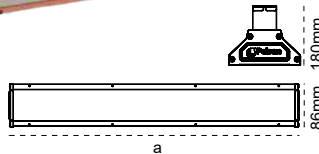

IP 65 4000K 6500K

Kod No	Özellikler	a (mm)	Koli Adedi	Fiyat
113336	100W 6500K Dar Açısı	600	1	179,80 \$
113338	150W 6500K Dar Açısı	900	1	233,40 \$
113340	200W 6500K Dar Açısı	1200	1	324,10 \$
113342	250W 6500K Dar Açısı	1500	1	373,30 \$
113344	300W 6500K Dar Açısı	1500	1	373,30 \$

## Etna G2 Frozen



**Soğuk Hava**

**Depoları için**

**Ultra Performans!**

**-40° C'ye Kadar Çalışır.**



IP 65 4000K 6500K

Kod No	Özellikler	a (mm)	Koli Adedi	Fiyat
113337	100W 6500K Dar Açısı	600	1	229,80 \$
113339	150W 6500K Dar Açısı	900	1	283,40 \$
113341	200W 6500K Dar Açısı	1200	1	374,10 \$
113343	250W 6500K Dar Açısı	1500	1	423,30 \$
113345	300W 6500K Dar Açısı	1500	1	423,30 \$

Kod No	Özellikler	Koli Adedi	Fiyat
316387	Etna G2 Busbar Askı Takımı	1	6,30 \$

## Pelsan Yüksek Tavan Armatürleri

**Hima G2**  
IP65 Alüminyum  
Yüksek Tavan Armatürü



**Hima G2**  
IP65 Alüminyum Yüksek Tavan Armatürü



**75W**  
**120lm/W**



+50.000 Saat  
Armatür Ömrü



ENEC  
Belgeli Sürücü



IP65  
Su Almaz!

IP 65 4000K 6500K

Kod No	Özellikler	a (mm)	Koli Adedi	Fiyat
111072	75W 6500K	900 mm	1	103,40 \$
111073	100W 6500K	900 mm	1	110,80 \$
111066	150W 6500K	1200 mm	1	134,80 \$

**Karpat G2**



IP 65 6500K

Kod No	Özellikler	a (mm)	Koli Adedi	Fiyat
111105	75W 6500K	1200 mm	1	70,20 \$
111766	120W 6500K	1200 mm	1	107,10 \$
113479	150W 6500K	1500 mm	1	127,40 \$

Kod No	Özellikler	Koli Adedi	Fiyat
316387	Etna G2 / Hima G2 / Karpat G2 Busbar Askı Takımı	1	6,30 \$
318032	Süphan / Largo Busbar Askı Takımı	1	6,30 \$

# Yüksek Tavan Armatürleri **Pelsan**



75-100W  
Ø295



150-200W  
Ø345



Ürün Tanıtım Broşürü



154lm/W'a Varan Etkinlik Faktörü



Acil Kit



Reflektör Opsiyonu



45°/90° Lens Seçeneği

**Driver Üstünlükleri**



ENEC Belgeli Sürücü



100.000 h Driver Ömrü



6kV Dahili Parafudr



-40°C +55°C



IP67



100-277Vac Gerilim Dalgalanmalarından Etkilenmez

## Castor G3 75W-100W IP65 Alm. Enj. Yüksek Tavan Armatürü

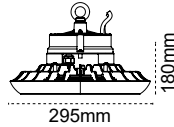

IP 65

Kod No	Özellikler	Koli Adedi	Fiyat
114042	75W 5700K	6	124,75 \$
114043	100W 5700K	6	135,50 \$

## Castor G3 150W-200W IP65 Alm. Enj. Yüksek Tavan Armatürü

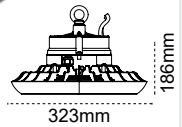

IP 65

Kod No	Özellikler	Koli Adedi	Fiyat
114044	150W 5700K	4	182,50 \$
114045	200W 5700K	4	225,50 \$

## Monte G2 100W IP65 Alm. Enj. Yüksek Tavan Armatürü

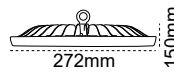

IP 65

Kod No	Özellikler	Koli Adedi	Fiyat
110569	100W 5700K	6	97,40 \$

## Monte G2 150W IP65 Alm. Enj. Yüksek Tavan Armatürü

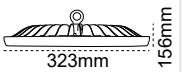

IP 65

Kod No	Özellikler	Koli Adedi	Fiyat
110570	150W 5700K	1	137,00 \$

Kod No	Özellikler	Koli Adedi	Fiyat
325718	Castor G2 Busbar Askı Takımı	1	3,70 \$
325458	Castor G2 Kamaşma Önleyici Reflektör	1	19,20 \$

# Pelsan Yüksek Tavan Armatürleri



Driver  
Üstünlükleri



ENEC Belgeli  
Sürücü



100.000 h  
Driver Ömrü



10kV Dahili  
Parafudr



-40°C +55°C



IP67



100-277Vac  
Gerilim Dalgalanmalarından Etkilenmez

Sia  
Yüksek Tavan Armatürü



5  
YIL  
GARANTİ

IP 65 4000K 6500K

Kod No	Özellikler	Koli Adedi	Fiyat
109221	150W 6500K	1	344,00 \$
109554	200W 6500K	1	363,00 \$

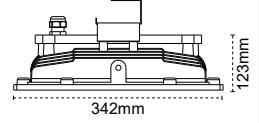

Sia Heavy Industry  
Yüksek Tavan Armatürü



Ağır Sanayi  
Tesisleri İçin  
Kesin Çözüm!

IP 65 4000K 6500K

Kod No	Özellikler	Koli Adedi	Fiyat
110603	100W 6500K	1	343,00 \$
110604	125W 6500K	1	350,00 \$
110605	150W 6500K	1	357,00 \$

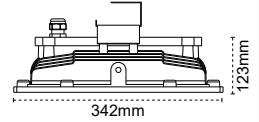

+70° C'ye Kadar Çalışır.

Ex-Proof Yüksek Tavan Arm.  
Sia



- Toz Patlama Koruması: Zone 22
- Gaz Patlama Koruması: Zone 2

IP 66 4000K 6500K

Kod No	Özellikler	Koli Adedi	Fiyat
111381	Sia Ex 50W 6500K	1	330,50 \$
111380	Sia Ex 75W 6500K	1	372,25 \$
111379	Sia Ex 100W 6500K	1	414,75 \$
111378	Sia Ex 125W 6500K	1	458,25 \$
111377	Sia Ex 150W 6500K	1	500,25 \$
111053	Sia Ex 200W 6500K	1	552,52 \$

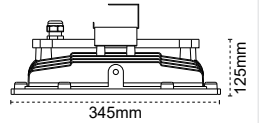

# Kapalı Spor Salonu Armatürleri **Pelsan**

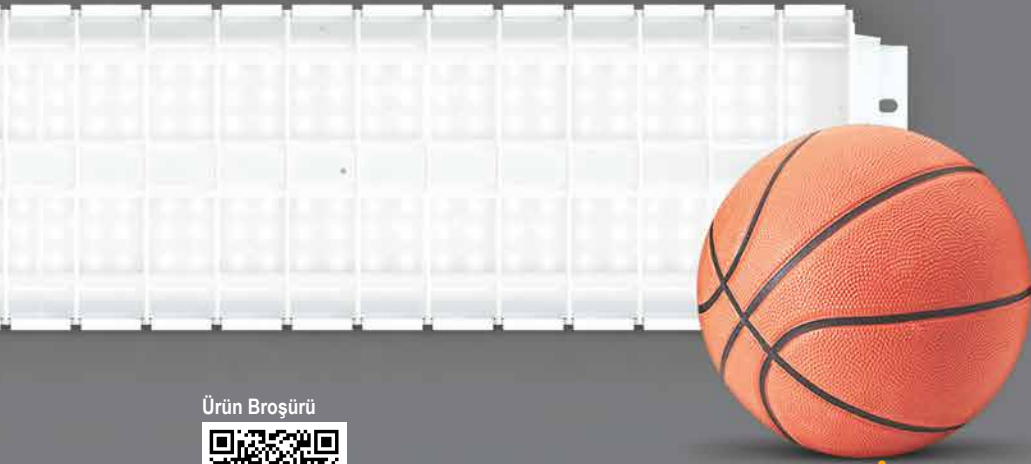

Ürün Broşürü



Profesyonel Spor Salonları İçin  
**Kusursuz** Aydınlatma Deneyimi

- IK10, Yüksek Darbe Dayanımı
- Kamaşma Önleyici Optik Tasarım
- HD Çekim Kalitesine Uygun
- 150 lm/W Etkinlik Faktörü
- Lens Opsiyonları

Lens Seçeneği

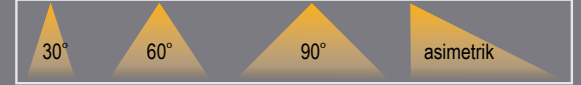

## Neta 60°

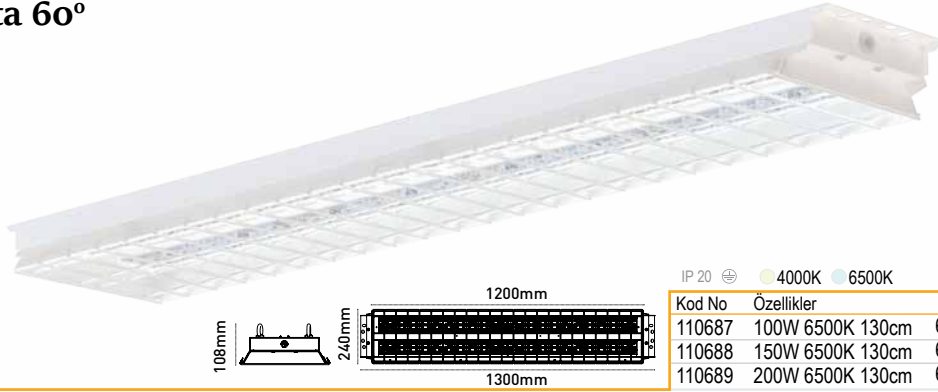

IP 20 4000K 6500K

Kod No	Özellikler	Koli Adedi	Fiyat
110687	100W 6500K 130cm 60°	1	328,00 \$
110688	150W 6500K 130cm 60°	1	369,00 \$
110689	200W 6500K 130cm 60°	1	410,00 \$

## Neta 90°

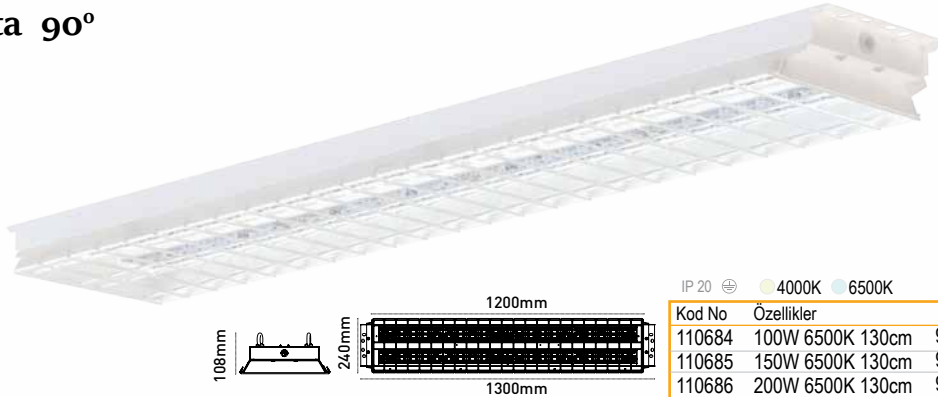

IP 20 4000K 6500K

Kod No	Özellikler	Koli Adedi	Fiyat
110684	100W 6500K 130cm 90°	1	328,00 \$
110685	150W 6500K 130cm 90°	1	369,00 \$
110686	200W 6500K 130cm 90°	1	410,00 \$

## Neta Asimetrik

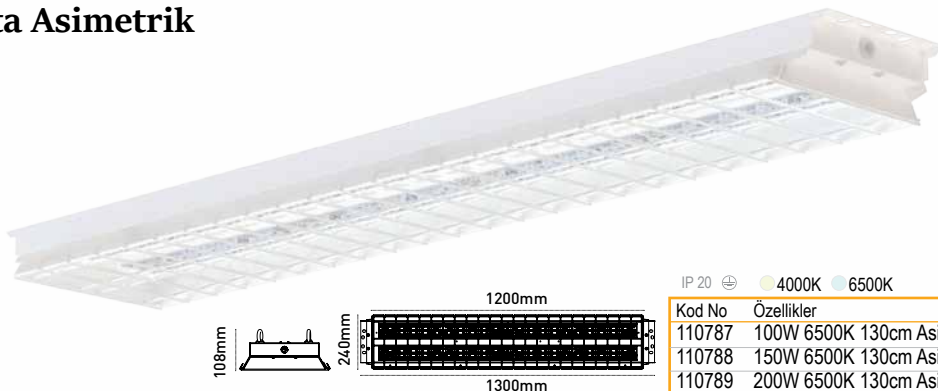

IP 20 4000K 6500K

Kod No	Özellikler	Koli Adedi	Fiyat
110787	100W 6500K 130cm Asimetrik	1	328,00 \$
110788	150W 6500K 130cm Asimetrik	1	369,00 \$
110789	200W 6500K 130cm Asimetrik	1	410,00 \$

# Pelsan Alçak Tavan Armatürleri

Yeni Ürün

## Inovaled Max



Alüminyum  
Gövde

Temperli  
Cam

IP66

Alüminyum Gövde

Temperli Cam

IP66, Toz ve su almaz

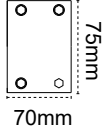

IP 65 3000K 4000K 6500K

Kod No	Özellikler	Koli Adedi	Fiyat
113643	100W 6500K 90cm	6	94,25 \$
113644	120W 6500K 120cm	6	115,50 \$
113645	150W 6500K 150 cm	6	125,50 \$

## Fontana Max



75W  
126 lm/W

PC, Kırılmaz  
Gövde

PC, Kırılmaz Gövde

Through Wiring Opsiyonu

IP65, IP66 Opsiyonlu

+126lm/W

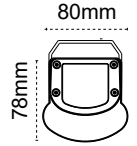

IP 65 3000K 4000K 6500K

Kod No	Özellikler	Koli Adedi	Fiyat
114465	50W 6500K 120cm	6	72,50 \$
114467	75W 6500K 120cm	6	76,50 \$

## Largo Max



75W  
128 lm/W

GRP  
Gövde

IP65, IP66 Opsiyonlu

Anti Korozyon GRP Gövde

+128lm/W

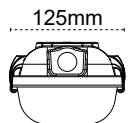

IP 65 3000K 4000K 6500K

Kod No	Özellikler	Koli Adedi	Fiyat
113888	50W 6500K 120 cm	6	68,50 \$
113230	75W 6500K 120 cm	6	73,50 \$





# Zone1, Zone21 ATEX Belgeli Ex-Proof Armatürler

Pelsan



Pelsan **Ex-Proof Armatürleri** Kimya ve boya tesisleri, petrol depolama tesisleri, petrol dolum boşaltım tesisleri, liman & tersaneler, enerji santralleri, endüstriyel tesisler ve akaryakıt istasyonlarında **güvenle kullanabilirsiniz!**

## LED Etanj

Yeni Ürün



ZONE 1  
ZONE 21  
II 2G Ex db IIB T6 Gb  
II 2D Ex tb IIIC T85°C Db

IP 66

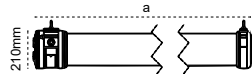

Kod No	Özellikler	(a)cm	Koli Adedi	Fiyat
112894	22W 6500K	71cm	1	375,00 \$
112896	44W 6500K	131cm	1	462,50 \$
112897	66W 6500K	131cm	1	462,50 \$

## Exit

Yeni Ürün



ZONE 1  
ZONE 21  
II 2G Ex db IIB T6 Gb  
II 2D Ex tb IIIC T85°C Db

IP 66

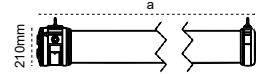

Kod No	Özellikler	(a)cm	Koli Adedi	Fiyat
112919	22W 6500K	71cm	1	478,80 \$



# Zone2, Zone22 ATEX Belgeli Ex-Proof Armatürler

Pelsan

● Toz Patlama Koruması: Zone 22 ● Gaz Patlama Koruması: Zone 2

## LED Ex-Proof Acil Ayd. Ausled IP65



Acil

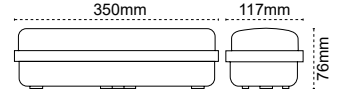

II 3G Ex ec IIC T5 Gc  
II 3D Ex tc IIC (T95°C) DC

IP 65

Kod No	Özellikler	Koli Adedi	Fiyat
109710	15W 6500K 3h Acil Aydınlatma Kiti	12	101,60 \$

## LED Tube Ex-Proof Etanj Largo IP65 60cm/120cm

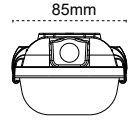

II 3G Ex ec IIC T5 Gc  
II 3D Ex tc IIC (T95°C) DC

IP 65

Kod No	Özellikler	Koli Adedi	Fiyat
111402	1x9W LED Tube Tekli Şeffaf 60cm	6	77,50 \$
111404	2x9W LED Tube İkili Şeffaf 60cm	6	79,50 \$
111405	1x18W LED Tube Tekli Şeffaf 120cm	6	97,50 \$
111406	2x18W LED Tube İkili Şeffaf 120cm	6	99,50 \$

## LED Ex-Proof Etanj Largo IP65 60cm/120cm



Acil

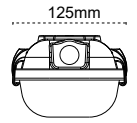

II 3G Ex ec IIC T5 Gc  
II 3D Ex tc IIC (T95°C) DC

IP 65

Kod No	Özellikler	Koli Adedi	Fiyat
108458	25W LED 6500K Opal 60cm	6	174,75 \$
108459	45W LED 6500K Opal 120cm	6	187,50 \$
113390	25W LED 6500K 3h Acil Aydınlatma Kiti 60cm	6	205,05 \$
114574	45W LED 6500K 3h Acil Aydınlatma Kiti 120cm	6	217,80 \$

## T8 Ex-Proof Etanj Largo IP65 60cm/120cm

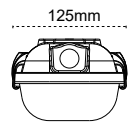

II 3G Ex ec IIC T5 Gc  
II 3D Ex tc IIC (T95°C) DC

IP 65

Kod No	Özellikler	Koli Adedi	Fiyat
108297	2x18W Şeffaf 60cm	6	110,50 \$
108298	2x36W Şeffaf 120cm	6	116,25 \$



# Zone2, Zone22 ATEX Belgeli Ex-Proof Armatürler

Pelsan

● Toz Patlama Koruması: Zone 22 ● Gaz Patlama Koruması: Zone 2

## Ex-Proof Projektör

Nairo



ZONE 2  
ZONE 22  
II 3G Ex ec IIC T5 Gc  
II 3D Ex tc IIIC (T95°C) DC

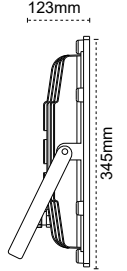

IP 65 ● 4000K ● 6500K

Kod No	Özellikler	Koli Adedi	Fiyat
111372	Nairo Ex 50W 6500K	1	330,50 \$
111371	Nairo Ex 75W 6500K	1	372,25 \$
111370	Nairo Ex 100W 6500K	1	414,75 \$
111369	Nairo Ex 125W 6500K	1	458,25 \$
111368	Nairo Ex 150W 6500K	1	500,25 \$
111055	Nairo Ex 200W 6500K	1	552,50 \$

## Ex-Proof Yüksek Tavan Arm.

Sia



ZONE 2  
ZONE 22  
II 3G Ex ec IIC T5 Gc  
II 3D Ex tc IIIC (T95°C) DC

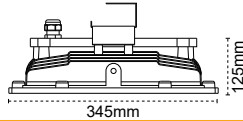

IP 66 ● 4000K ● 6500K

Kod No	Özellikler	Koli Adedi	Fiyat
111381	Sia Ex 50W 6500K	1	330,50 \$
111380	Sia Ex 75W 6500K	1	372,25 \$
111379	Sia Ex 100W 6500K	1	414,75 \$
111378	Sia Ex 125W 6500K	1	458,25 \$
111377	Sia Ex 150W 6500K	1	500,25 \$
111053	Sia Ex 200W 6500K	1	552,50 \$

## 50W Ex-Proof Projektör

Elit Lirad



ZONE 2  
ZONE 22  
II 3G Ex ec IIC T5 Gc  
II 3D Ex tc IIIC (T95°C) DC

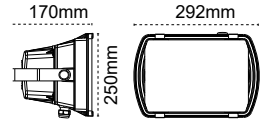

IP 66 ● 4000K ● 6500K

Kod No	Özellikler	Koli Adedi	Fiyat
109707	Elit Lirad Ex 50W 6500K	6	221,60 \$

## Ex-Proof Kanopi Armatürü

Piroliz



ZONE 2  
ZONE 22  
II 3G Ex ec IIC T5 Gc  
II 3D Ex tc IIIC (T95°C) DC

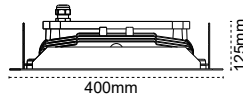

IP 66 ● 4000K ● 6500K

Kod No	Özellikler	Koli Adedi	Fiyat
111376	Piroliz Ex 50W 6500K	1	330,50 \$
111375	Piroliz Ex 75W 6500K	1	372,25 \$
111374	Piroliz Ex 100W 6500K	1	414,75 \$
111382	Piroliz Ex 125W 6500K	1	458,25 \$
111373	Piroliz Ex 150W 6500K	1	500,25 \$
111056	Piroliz Ex 200W 6500K	1	552,50 \$

## Ex-Proof Yol-Cadde Armatürü

Nairo



ZONE 2  
ZONE 22  
II 3G Ex ec IIC T5 Gc  
II 3D Ex tc IIIC (T95°C) DC

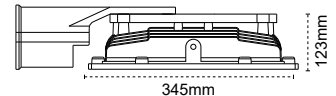

IP 66 ● 4000K ● 6500K

Kod No	Özellikler	Koli Adedi	Fiyat
111365	Nairo Ex 100W 4000K	1	430,50 \$
111364	Nairo Ex 125W 4000K	1	474,00 \$
111363	Nairo Ex 150W 4000K	1	516,00 \$
111362	Nairo Ex 200W 4000K	1	568,25 \$

## Pelsan Wallwasher

Uzun Ömürlü, Yüksek Verimli...

Gaziantep Kalesi LED Aydınlatması,  
Pelsan Aydınlatma M. Reşit Göğüş tarafından yapılmıştır.



IP66 Toz ve Su Almaz



Temperli Cam



IK08 Darbe Dayanımı



Alüminyum Gövde

Hava Ventilli Rakor ile Nem Yapmaz!

## S.Ü. Wallwasher IP66 Inoaled G2



Renk Farkı  
**YOK!**

● AMBER ● YEŞİL ● MAVİ ● KIRMIZI



14W

35 cm



28W

65 cm



42W

95 cm

Renk Opsiyonları



Lens Açısı

45+20°

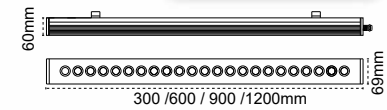

IP 66

IP 66

Kod No	Özellikler	Koli Adedi	Fiyat
113291	14W 45+20 Derece 4000K 350mm	1	41,80 \$
113319	28W 45+20 Derece 4000K 650mm	1	67,20 \$

Kod No	Özellikler	Koli Adedi	Fiyat
113327	42W 45+20 Derece 4000K 945mm	1	104,95 \$

Cruzo IP66

**1000W**  
LED Projektör

ürün videosu

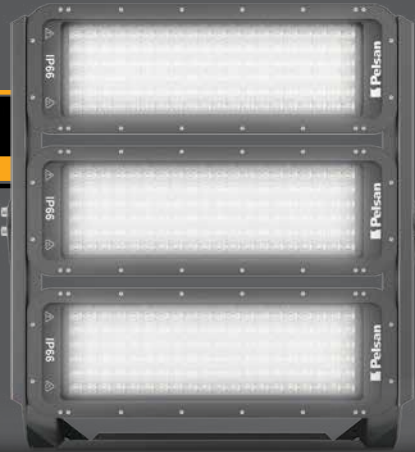

**Cruzo şimdi**  
**CB, ENEC belgeli**

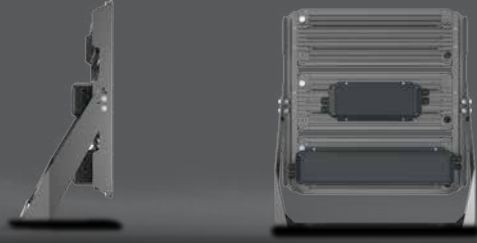

Driver  
Üstünlükleri



ENEC Belgeli  
Sürücü



100.000 h  
Driver Ömrü



10kV Dahili  
Parafudr



-40°C +55°C



IP67



100-277Vac  
Gerilim Dalgalarıyla Etkilenmez

Cruzo IP66 300-500W  
LED Projektör

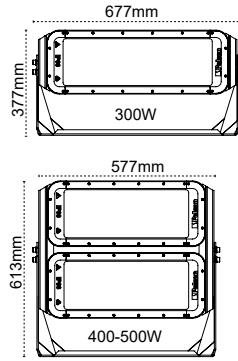

IP 66

Kod No	Özellikler	axbxc mm	Koli Adedi	Fiyat
110791	300W 5700K	677x377x226	1	474,40 \$
110792	400W 5700K	577x613x294	1	776,70 \$
110793	500W 5700K	577x613x294	1	776,70 \$

Cruzo IP66 600W  
LED Projektör

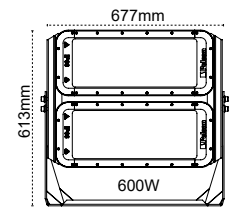

IP 66

Kod No	Özellikler	axbxc mm	Koli Adedi	Fiyat
110794	600W 5700K	677x613x294	1	911,10 \$

Cruzo IP66 800-1000W  
LED Projektör

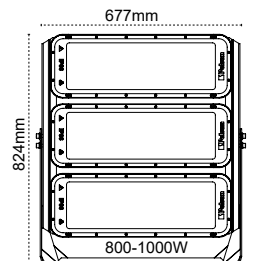

IP 66

Kod No	Özellikler	axbxc mm	Koli Adedi	Fiyat
110795	800W 5700K	677x824x345	1	1.437,80 \$
110796	900W 5700K	677x824x345	1	1.437,80 \$
110797	1000W 5700K	677x824x345	1	1.437,80 \$

# Reflektörlü Özgün Tasarım



**Simetrik**  
100-150W



**Asimetrik**  
180-240W



**Simetrik**  
180-300W

## Driver Üstünlükleri



ENEC Belgeli  
Sürücü



100.000 h  
Driver Ömrü



10kV Dahili  
Parafudr



-40°C +55°C



IP67



100-277Vac  
Gerilim Dalgalanmalarından Etkilenmez

### Ria IP66 Simetrik 180-300w

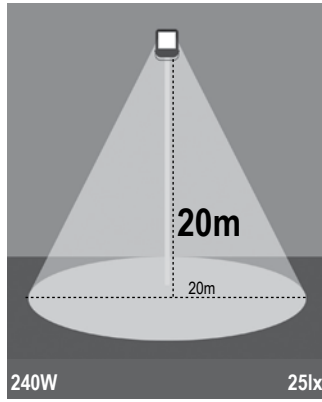

### EN YÜKSEK Direkler İçin...

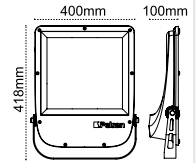

IP 66 3000K 4000K 6500K

Kod No	Özellikler	Koli Adedi	Fiyat
107140	180W Simetrik 6500K	1	288,60 \$
107141	200W Simetrik 6500K	1	297,60 \$
107130	240W Simetrik 6500K	1	316,90 \$
109218	300W Simetrik 6500K	1	345,30 \$

### Ria IP66 Asimetrik 180-240w



### İŞIĞI UZAĞA ATAN Asimetrik Tasarım

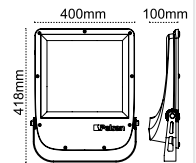

IP 66 3000K 4000K 6500K

Kod No	Özellikler	Koli Adedi	Fiyat
107137	180W Asimetrik 6500K	1	282,70 \$
107138	200W Asimetrik 6500K	1	291,50 \$
107127	240W Asimetrik 6500K	1	310,40 \$

### Ria IP66 100-150w

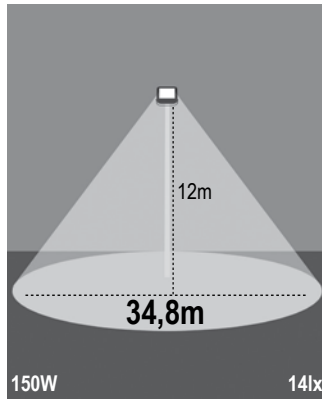

### GENİŞ Alanlar için...

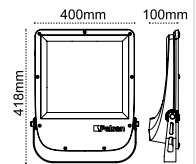

IP 66 3000K 4000K 6500K

Kod No	Özellikler	Koli Adedi	Fiyat
109209	100W Simetrik 6500K	1	238,30 \$
109210	125W Simetrik 6500K	1	248,20 \$
109211	150W Simetrik 6500K	1	248,20 \$



**200-400W**

Ria Lens



**60-150W**

Ria Med G2



**Driver  
Üstünlükleri**



**ENEC Belgeli  
Sürücü**



**100.000 h  
Driver Ömrü**



**10kV Dahili  
Parafudr**



**-40°C +55°C**



**IP67**



**100-277Vac**  
Gerilim Dalgalanmalarından Etkilenmez

**Ria Med G2**

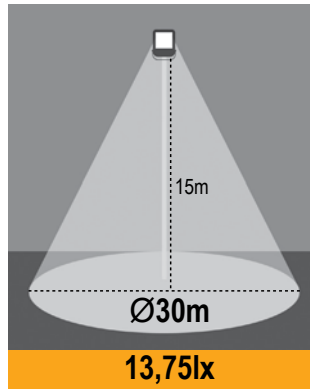

**W 60 - 150W**

**8820 - 19050 lm**

**IK09 Darbe Dayanımı**

IP 66 3000K 4000K 6500K

Kod No	Özellikler	Koli Adedi	Fiyat
111788	60W 6500K	4	112,25 \$
111785	80W 6500K	4	142,50 \$
111660	100W 6500K	4	142,50 \$
111666	150W 6500K	4	166,00 \$

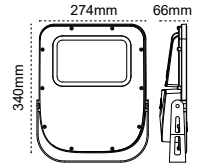

**Ria IP66 Simetrik  
180-400w**

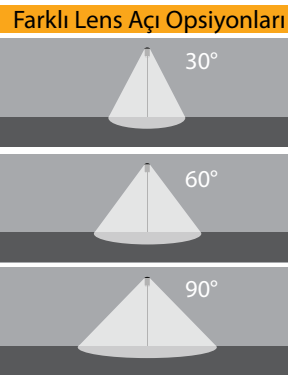

**FARKLI LENS AÇILARI**  
**30°-60°-90°**

IP 66 3000K 4000K 6500K

Kod No	Özellikler	Koli Adedi	Fiyat
110356	200W Simetrik 6500K 90° Lens	1	362,40 \$
110355	250W Simetrik 6500K 90° Lens	1	386,00 \$
110354	300W Simetrik 6500K 90° Lens	1	425,80 \$
115039	400W Simetrik 6500K 90° Lens	1	425,80 \$

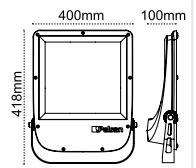

**Ria IP66 Asimetrik  
180-240w**



**İŞİĞİ UZAĞA ATAN  
Asimetrik Tasarım**

IP 66 3000K 4000K 6500K

Kod No	Özellikler	Koli Adedi	Fiyat
110770	200W Asimetrik 6500K	1	362,40 \$
110771	250W Asimetrik 6500K	1	386,00 \$
110772	300W Asimetrik 6500K	1	425,80 \$

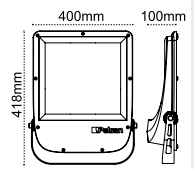

# Pelsan Projektörler

## Sterio IP66



50 / 450W Güç Opsiyonu



+100 lm/W



IP66 Su ve Toz Almaz



IK10 Gövde

### Sterio IP66 450W LED Projektör

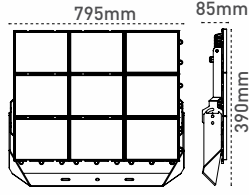

IP 66

Kod No	Özellikler	Koli Adedi	Fiyat
109538	450W 5700K	1	471,95 \$

### Sterio IP66 300W LED Projektör

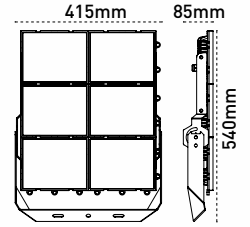

IP 66

Kod No	Özellikler	Koli Adedi	Fiyat
109537	300W 5700K	1	356,25 \$

### Sterio IP66 200W LED Projektör

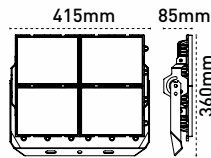

IP 66

Kod No	Özellikler	Koli Adedi	Fiyat
109536	200W 5700K	1	228,95 \$

### Sterio IP66 100W / 50W LED Projektör

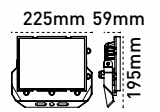
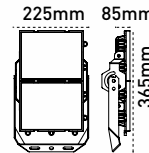

IP 66

Kod No	Özellikler	Koli Adedi	Fiyat
109666	100W 5700K	1	98,25 \$
109787	50W 5700K	1	49,25 \$

### Franko 400W

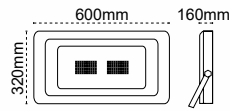

IP 65

Kod No	Özellikler	Koli Adedi	Fiyat
114334	400W 5000K	1	434,40 \$

### Franko 200W

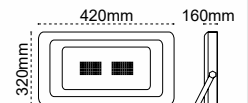

IP 65

Kod No	Özellikler	Koli Adedi	Fiyat
114128	200W 5000K	1	210,60 \$



Tartışmasız **EN İYİSİ** Lecto



**YENİ  
300W**

Lecto sıradan projektörlere göre;

- **%45 daha ağır gövdeye sahiptir.** Etkin soğutma sağlar. Uzun ömürlüdür.
- **%33 daha fazla ışık çıktısı sunar.** 100lm/W etkinlik faktörüne sahiptir.
- Güçlü elektriksel tasarımı ile **arıza yapmaz.**
  - Giriş gerilim filtresi
  - Akım sınırlayıcı
  - Giriş gerilim toleransı geniştir.



1 Hava Ventili ile Nem Yapmaz



2 360° Döner Konsol



3 Metal Rakor



4 Alüminyum Enjeksiyon Gövde

**300W LED Projektör**  
Lecto

**Yeni Ürün**

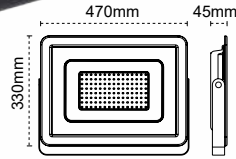

IP 65

Kod No	Özellikler	Koli Adedi	Fiyat
114120	300W 5000K	4	203,50 \$

**200W LED Projektör**  
Lecto

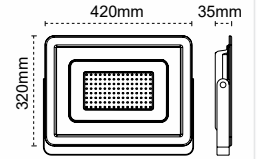

IP 65

Kod No	Özellikler	Koli Adedi	Fiyat
111284	200W 5000K	2	133,00 \$

**150W LED Projektör**  
Lecto

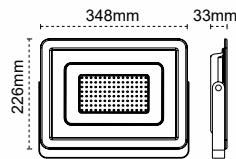

IP 65

Kod No	Özellikler	Koli Adedi	Fiyat
109306	150W 5000K	2	94,50 \$

**100W / 50W LED Projektör**  
Lecto

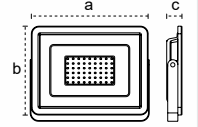

IP 65

Kod No	Özellikler	axbxcmm	Koli Adedi	Fiyat
109305	100W 5000K	300x225x33	4	53,60 \$
109304	50W 5000K	230x175x30	6	25,50 \$

# Pelsan Profesyonel Solar Aydınlatma Armatürü

## Prof. Solar Ayd. Armatürü Rio Xs G2

Yeni Ürün



\* Direk fiyata dahil değildir.

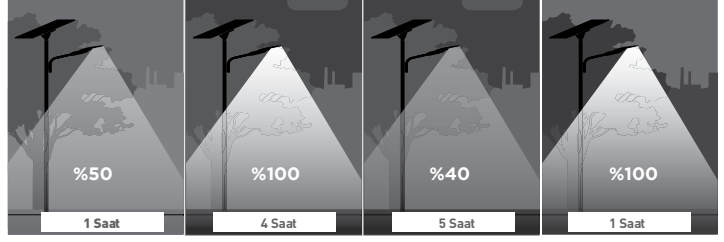
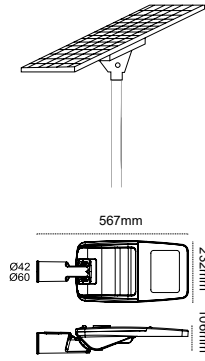

IP 65

Kod No	Özellikler	Koli Adedi	Fiyat
114957	20W 4000K	1	376,00 \$
114958	40W 4000K	1	684,00 \$
114981	60W 4000K	1	904,00 \$
114960	80W 4000K	1	1.173,00 \$
114961	100W 4000K	1	1.417,00 \$

## Prof. Solar Ayd. Armatürü Doka G2

Yeni Ürün



\* Direk fiyata dahil değildir.

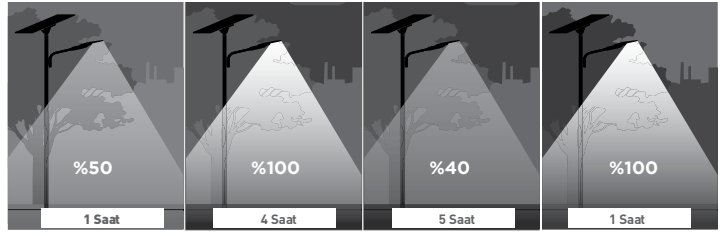
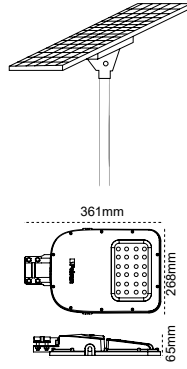

IP 65

Kod No	Özellikler	Koli Adedi	Fiyat
114962	20W 4000K	1	356,00 \$
114963	40W 4000K	1	664,00 \$
114964	60W 4000K	1	884,00 \$
114965	80W 4000K	1	1.153,00 \$
114966	100W 4000K	1	1.397,00 \$

## Prof. Solar Ayd. Armatürü Madrid

Yeni Ürün



\* Direk fiyata dahil değildir.

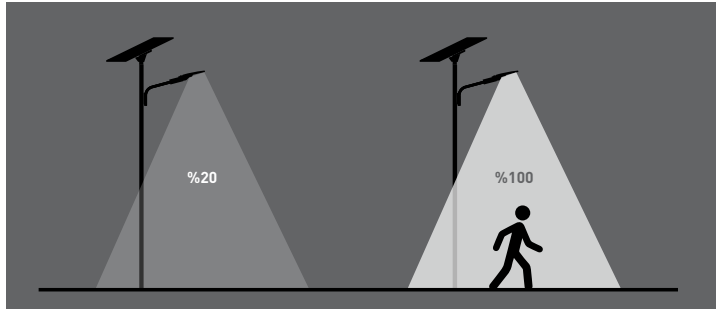
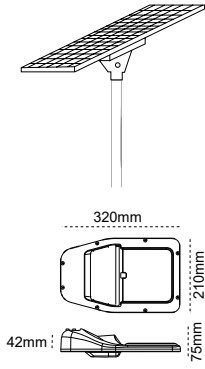

IP 54

Kod No	Özellikler	Koli Adedi	Fiyat
114991	20W 4000K	1	336,00 \$
114993	40W 4000K	1	644,00 \$

## Solar Armatür Direği

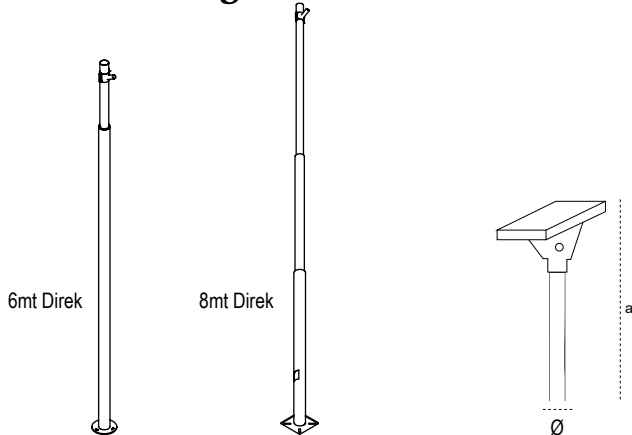

Kod No	Özellikler	Koli Adedi	Fiyat
208468	Ø42mm 4m Direk RAL7043	1	162,50 \$
208469	Ø60mm 4m Direk RAL7043	1	162,50 \$
208474	Ø42mm 6m Direk RAL7043	1	304,50 \$
208475	Ø60mm 6m Direk RAL7043	1	304,50 \$
208476	Ø42mm 8m Direk RAL7043	1	646,50 \$
208477	Ø60mm 8m Direk RAL7043	1	646,50 \$

# Solar Aydınlatma Armatürü

## 40W Solar Aydınlatma Armatürü Accra

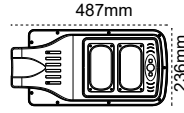

Kumanda ile  
Kontrol

- 1 Mod 1: Radar sensörü aktif eder.
- 2 Mod 2: Radar sensör aktif değil. %50 yanar.
- 3 Mod 3: Kapalı
- 4 Mod 4: Zaman ayarı / Sürekli yanar mod

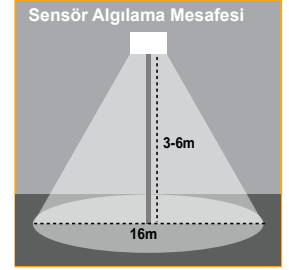

CE

IP 65

Kod No Özellikler  
109431 40W 6500K

Koli Adedi Fiyat  
10 77,25 \$

## 60W Solar Aydınlatma Armatürü Accra

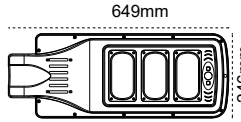

Kumanda ile  
Kontrol

- 1 Mod 1: Radar sensörü aktif eder.
- 2 Mod 2: Radar sensör aktif değil. %50 yanar.
- 3 Mod 3: Kapalı
- 4 Mod 4: Zaman ayarı / Sürekli yanar mod

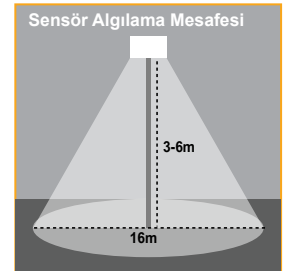

CE

IP 65

Kod No Özellikler  
109432 60W 6500K

Koli Adedi Fiyat  
10 104,75 \$

## 50W Solar Projektör Accra

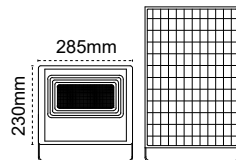

Kumanda ile  
Kontrol

IP 65  
Kod No Özellikler  
114064 50W 6500K

Yeni Ürün

CE

Koli Adedi Fiyat  
1 77,00 \$

## 100W Solar Projektör Accra

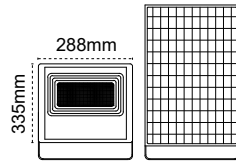

Kumanda ile  
Kontrol

IP 65  
Kod No Özellikler  
114065 100W 6500K

Yeni Ürün

CE

Koli Adedi Fiyat  
1 117,00 \$

# Pelsan Yol ve Cadde Armatürleri

## Rio XS G2 IP66



30-50-60-80-100W 

IP66, Toz ve Su Almaz! 

Alüminyum Enjeksiyon Gövde 

IP67, ENEC Belgeli Sürücü 

LED Çip Ömrü, +100.000 hrs 

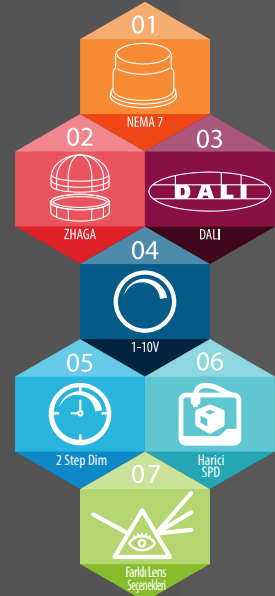

★ Gece Modu Opsiyonu  
★ 02:00'den Sonra Otomatik Dim



Tool Free Tasarım



Açı Ayarlanabilir Konsol (0° - 5° - 10° - 15°)



165lm/W'a  
Varan Verimlilik

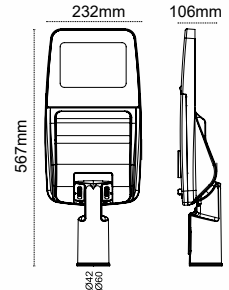

IP 66  ● 3000K ● 4000K ● 6500K

Kod No	Özellikler	Koli Adedi	Fiyat
110975	50W 4000K	1	158,00 \$
110974	60W 4000K	1	158,00 \$
110973	80W 4000K	1	170,50 \$
110972	100W 4000K	1	170,50 \$

## Rio IP66



163lm/W'a Varan Verimlilik



LED Çip: L90 @105 °C 86.000 Saat Ömür



ENEC Belgeli LED Sürücü



-35 / +50 °C Çalışma Sıcaklığı



10 kV Yüksek Gerilim Koruması



IK10 Alüminyum Enjeksiyon Gövde



5 Farklı Konsol Açısı

★ Gece Modu Opsiyonu  
★ 02:00'den Sonra Otomatik Dim

## Rio S G2 IP66

80-150W



163lm/W'a  
Varan Verimlilik

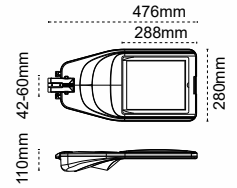

IP 66 3000K 4000K 6500K

Kod No	Özellikler	Koli Adedi	Fiyat
115117	80W 4000K RAL 7043	1	247,25 \$
115119	100W 4000K RAL 7043	1	247,25 \$
115141	125W 4000K RAL 7043	1	257,25 \$
115142	150W 4000K RAL 7043	1	257,25 \$

## Rio M G2 IP66

180-200W



160lm/W'a  
Varan Verimlilik

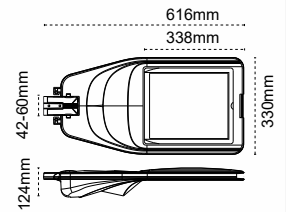

IP 66 3000K 4000K 6500K

Kod No	Özellikler	Koli Adedi	Fiyat
115125	180W 4000K RAL 7043	1	366,25 \$
115126	200W 4000K RAL 7043	1	366,25 \$

## Rio L IP66

240-300W

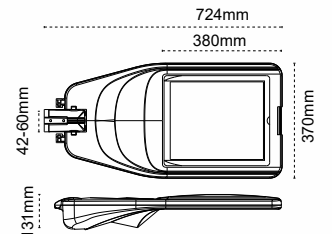

IP 66 3000K 4000K 6500K

Kod No	Özellikler	Koli Adedi	Fiyat
110784	240W 4000K RAL 7043	1	520,25 \$
110785	270W 4000K RAL 7043	1	520,25 \$
110786	300W 4000K RAL 7043	1	520,25 \$

## Pelsan Yol ve Cadde Armatürleri

Doka G2 IP66

### Maksimum Performans İçin...



147lm/W'a  
Varan Verimlilik



IP66 Toz ve Su Almaz!



+54.000 Saat Ömür  
LED Çip



ENEC Belgeli Driver @Tc - 70°C  
100.000 Saat Ömür

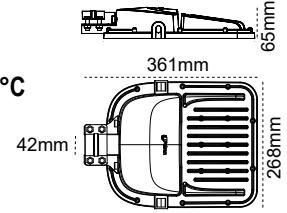

IP 66 4000K 6500K

Kod No	Özellikler	Koli Adedi	Fiyat
111793	60W 4000K	4	124,50 \$
111795	80W 4000K	4	133,75 \$
111797	100W 4000K	4	133,75 \$
111799	150W 4000K	4	177,25 \$

Madrid

### Hem Ekonomik, Hem Verimli!

ürün  
videosu



146lm/W'a  
Varan Verimlilik



146 lm/W' Varan Etkinlik Faktörü



ENEC Belgeli Sürücü



+50.000 Saat Sistem Ömrü

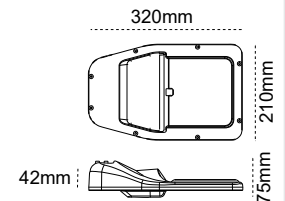
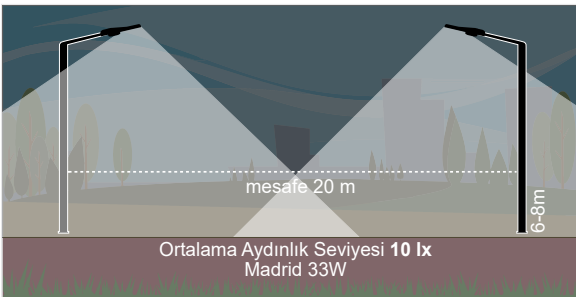

IP 65 4000K 6500K

Kod No	Özellikler	Koli Adedi	Fiyat
109841	20W 4000K	6	49,90 \$
108494	33W 4000K	6	58,00 \$
109877	40W 4000K	6	72,30 \$

Berlin

## Ekonomik Fiyat 4 Farklı Güç!

Alüminyum Enjeksiyon Gövde



110 lm / W



IP65, Toz ve Su Almaz!



**Berlin**  
60W

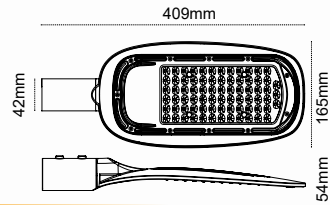

IP 65

Kod No Özellikler  
113622 60W 5000K

Koli Adedi Fiyat  
10 64,70 \$

**Berlin**  
80W

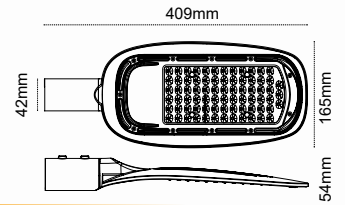

IP 65

Kod No Özellikler  
114994 80W 5000K

Koli Adedi Fiyat  
6 93,40 \$

**Berlin**  
100W

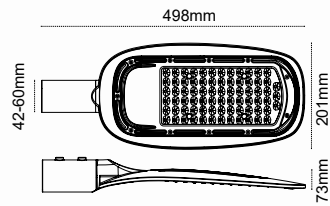

IP 65

Kod No Özellikler  
113623 100W 5000K

Koli Adedi Fiyat  
6 108,00 \$

**Berlin**  
150W

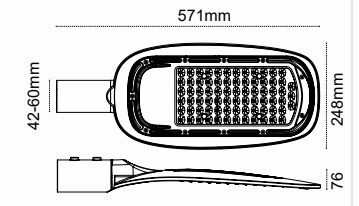

IP 65

Kod No Özellikler  
109856 150W 5000K

Koli Adedi Fiyat  
6 157,30 \$

# Pelsan Park Bahçe Aydınlatma Armatürleri

## Olimos

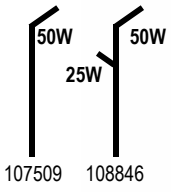
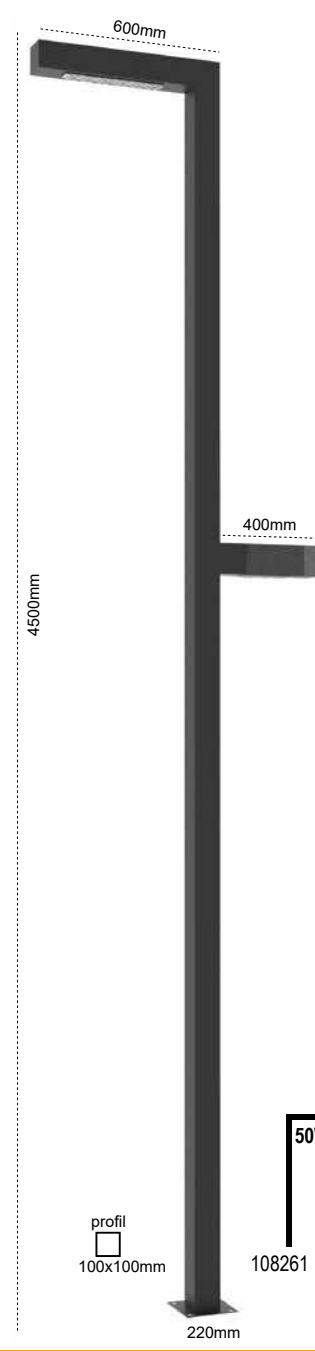
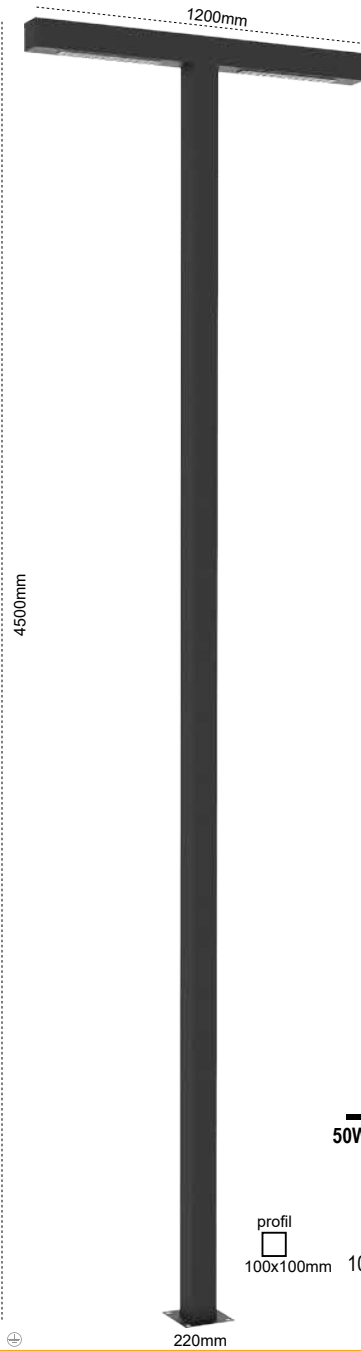
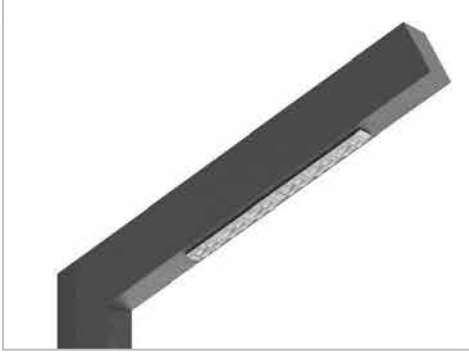

107509 108846

profil  
100x100mm

Kod No	Ozellikler	Koli Adedi	Fiyat
107509	50W 4000K	1	606,00 \$
108846	50+25W 4000K	1	726,00 \$

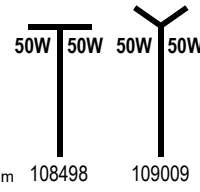

profil  
100x100mm

108498 109009

Kod No	Ozellikler	Koli Adedi	Fiyat
108498	50+50W 4000K	1	849,00 \$

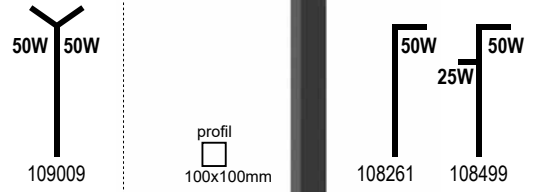

profil  
100x100mm

108261 108499

Kod No	Ozellikler	Koli Adedi	Fiyat
108261	50W 4000K	1	606,00 \$
108499	50+25W 4000K	1	726,00 \$



## Olimpos Med Serisi

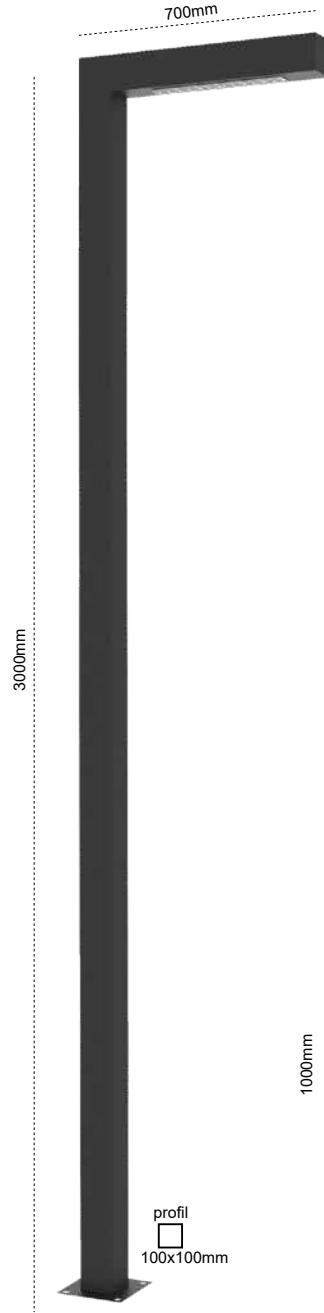
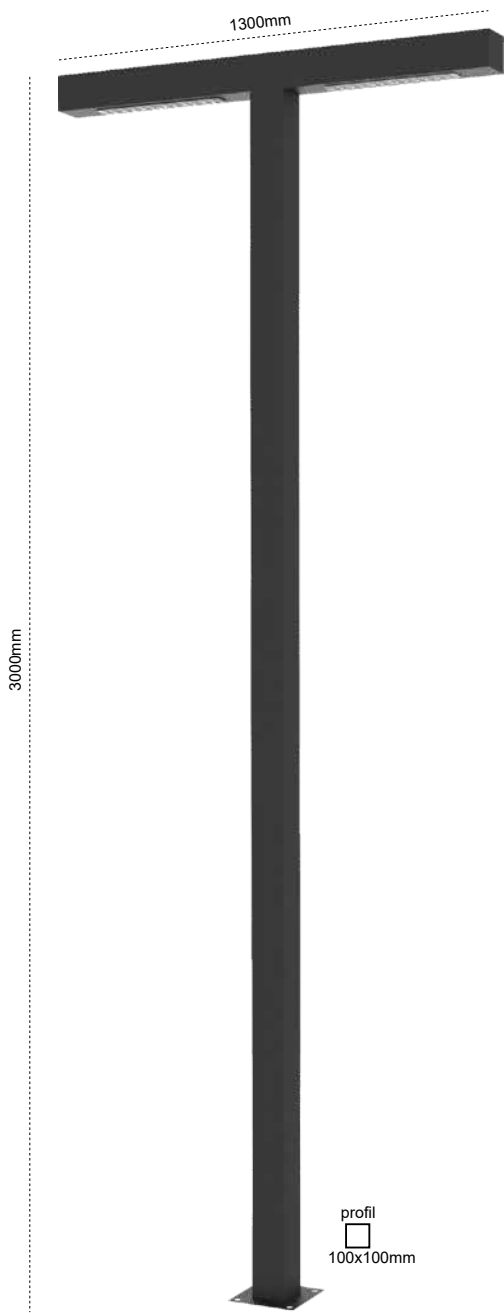
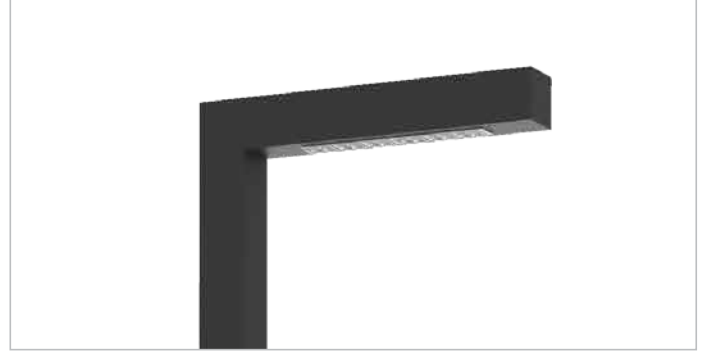

**EKONOMİK  
FİYAT**

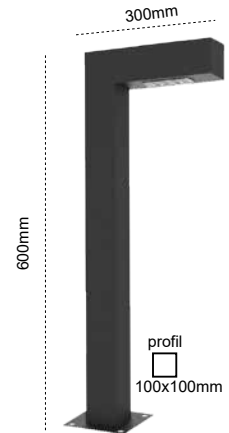
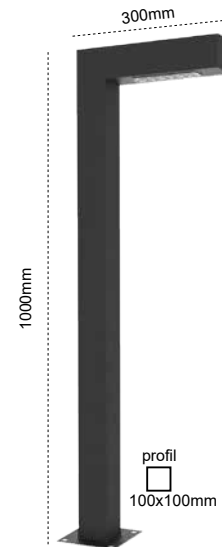

IP 65

Kod No	Özellikler	Koli Adedi	Fiyat
206073	Direk 1x30W 4000K 300cm	1	271,25 \$
206072	Direk 2x30W 4000K 300cm	1	333,50 \$

IP 65

Kod No	Özellikler	Koli Adedi	Fiyat
206074	Bolard 14W 4000K 60cm	1	118,50 \$
206075	Bolard 18W 4000K 100cm	1	132,50 \$

# Pelsan Park Bahçe Aydınlatma Armatürleri

## Palmira

109735 4500mm 1000mm 650mm 300x350mm 100x200mm profil 25W 50W

109733 6000mm 900mm 300x350mm 100x200mm profil 75W 75W 50W

109408 6000mm 1600mm 300x350mm 100x200mm profil 75W 75W

Kod No	Özellikler	Koli Adedi	Fiyat
109735	50+25W 4000K	1	1.130,00 \$

Kod No	Özellikler	Koli Adedi	Fiyat
109733	75W 4000K	1	1.290,00 \$
109734	50+75W 4000K	1	1.570,00 \$

Kod No	Özellikler	Koli Adedi	Fiyat
109408	75+75W 4000K	1	1.755,00 \$



## Maximum Görsel Konfor



Kamaşma Önleyici Özel Difüzörü ile Görsel Konfor Sağlar

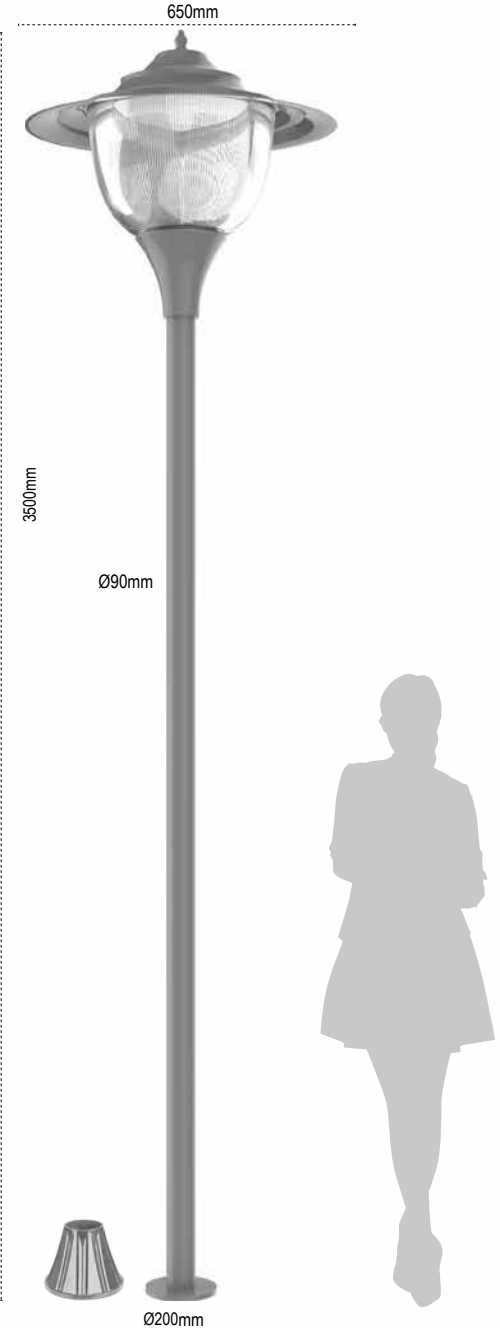

Kamaşma kontrollü özel difüzör



Özel prizmatik difüzör



Kamaşma yapmayan optik dizayn



Yüksek ışık geçirgenliği

Farklı RAL Kodu Uygulaması



RAL9005

RAL9006

RAL7043

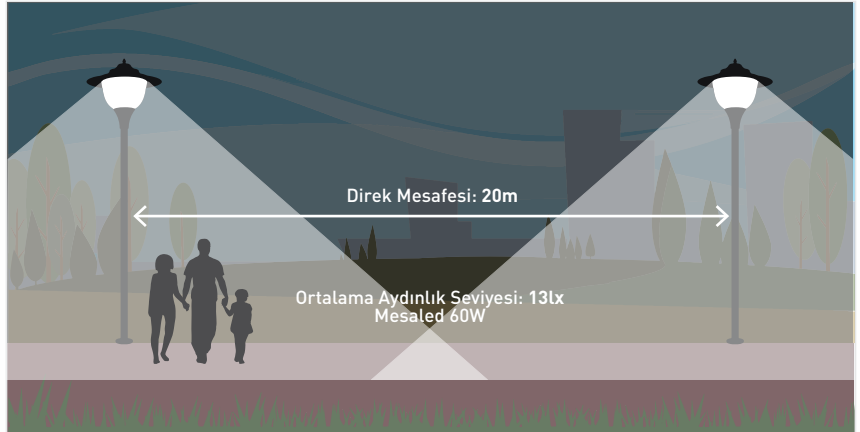

### Mesaled

IP 54

Kod No	Özellikler	Koli Adedi	Fiyat
108609	30W 4000K	1	321,50 \$
108608	60W 4000K	1	353,50 \$

# Pelsan Park Bahçe Aydınlatma Armatürleri

## Limra

- Alüminyum Gövde
- Opal Difüzör
- Alüminyum Reflektör

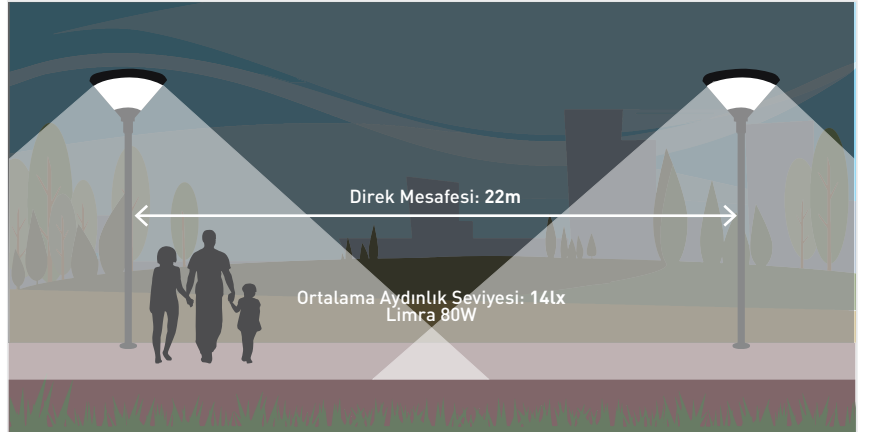
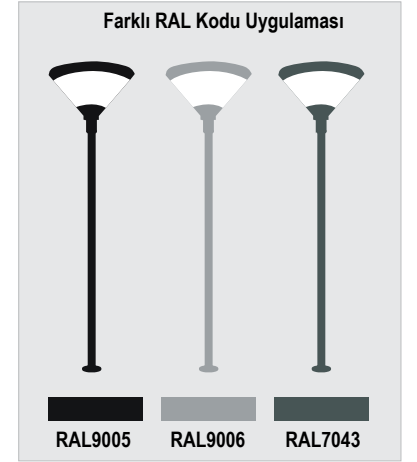
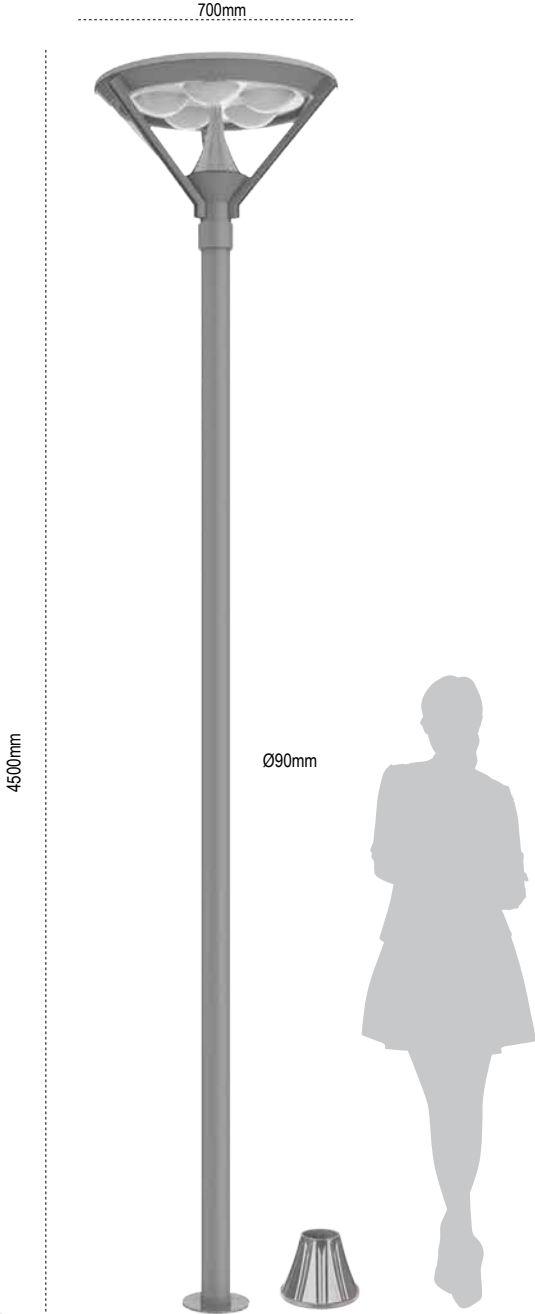
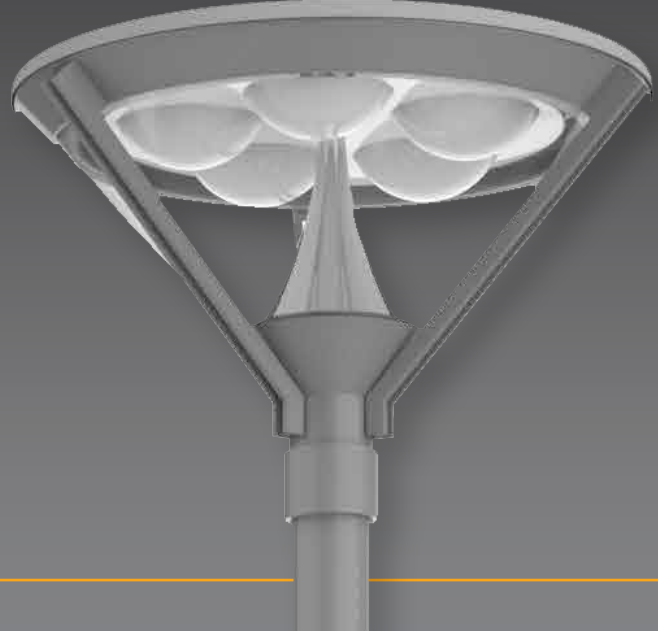

## Limra

Kod No	Özellikler	Koli Adedi	Fiyat
108606	38W LED 4000K 3'lü	1	557,00 \$
108605	80W LED 4000K 5'li	1	724,00 \$

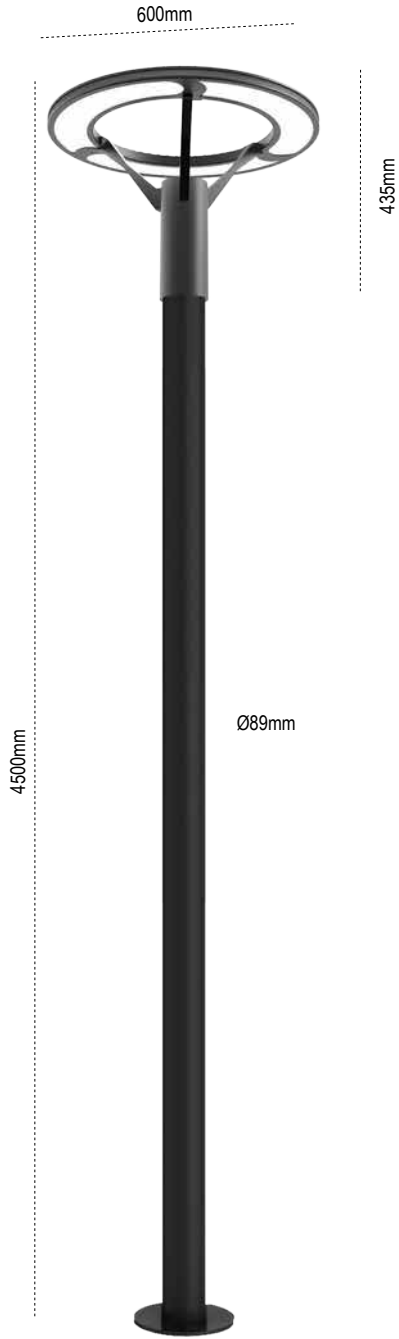

**Troya G2** Ø240mm

IP 54

Kod No	Özellikler	Koli Adedi	Fiyat
206776	25W 4000K	1	676,50 \$
206780	50W 4000K	1	676,50 \$
206783	75W 4000K	1	705,50 \$

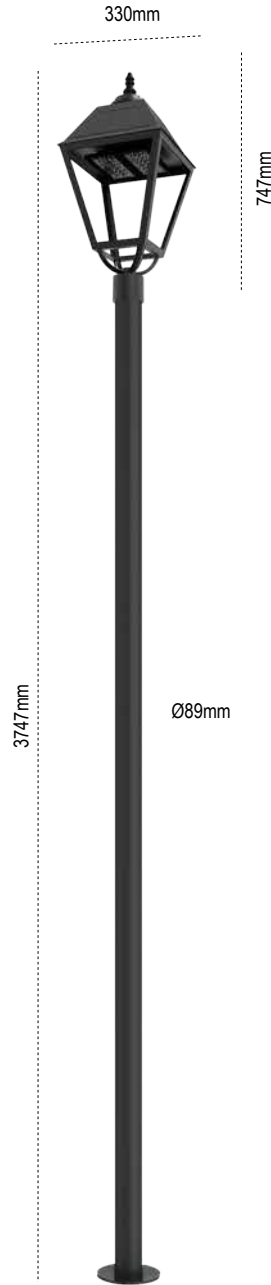

**Karya** Ø240mm

IP 54

Kod No	Özellikler	Koli Adedi	Fiyat
206804	25W 4000K	1	567,75 \$
206807	50W 4000K	1	582,75 \$
206810	75W 4000K	1	596,75 \$

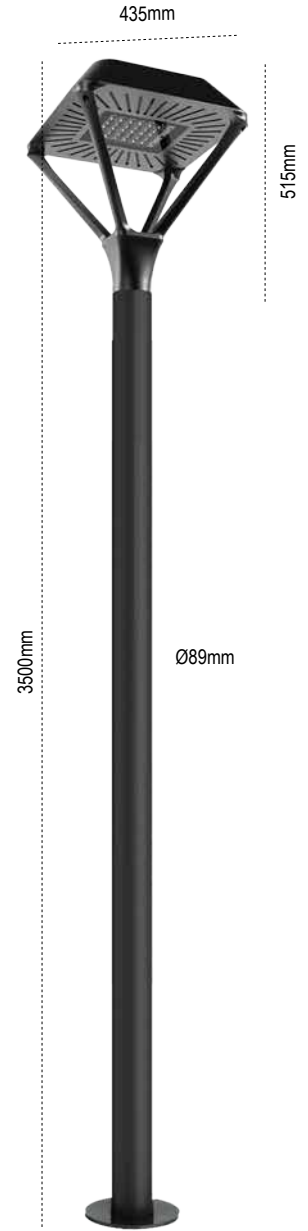

**Knidos** Ø240mm

IP 54

Kod No	Özellikler	Koli Adedi	Fiyat
206786	25W 4000K	1	729,50 \$
206789	50W 4000K	1	744,50 \$
206792	75W 4000K	1	759,50 \$

# Pelsan Park Bahçe Aydınlatma Armatürleri

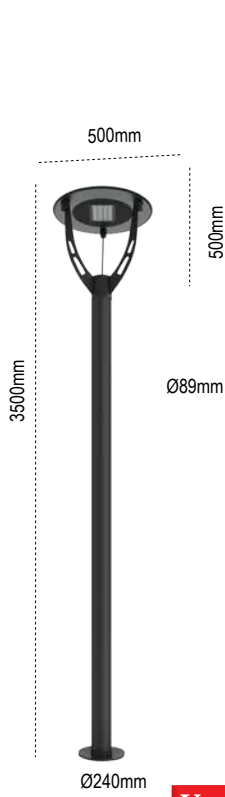

**Parion**

Ø240mm

**Yeni Ürün**

IP 54 ☺

Kod No	Özellikler	Koli Adedi	Fiyat
206813	25W 4000K	1	582,75 \$
206816	50W 4000K	1	596,75 \$
206819	75W 4000K	1	611,75 \$

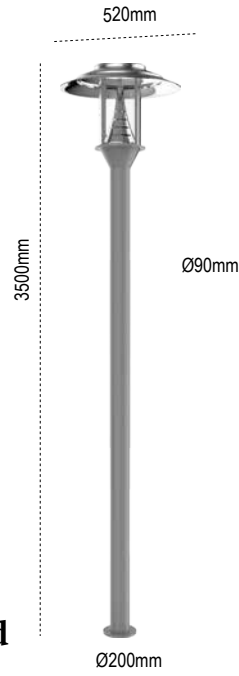

**Evaled**

Ø200mm

IP 54 ☺

Kod No	Özellikler	Koli Adedi	Fiyat
108610	40W LED 4000K	1	592,00 \$

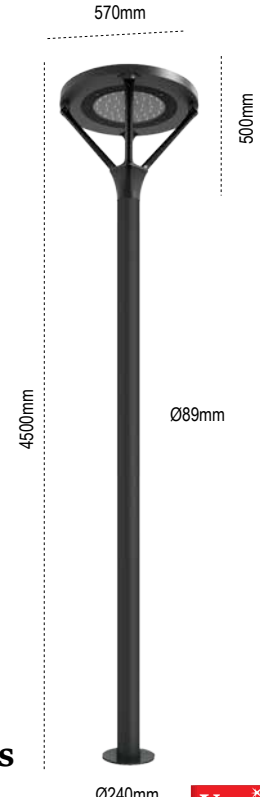

**Sardes**

Ø240mm

**Yeni Ürün**

IP 54 ☺

Kod No	Özellikler	Koli Adedi	Fiyat
206795	25W 4000K	1	691,50 \$
206798	50W 4000K	1	705,50 \$
206801	75W 4000K	1	720,50 \$

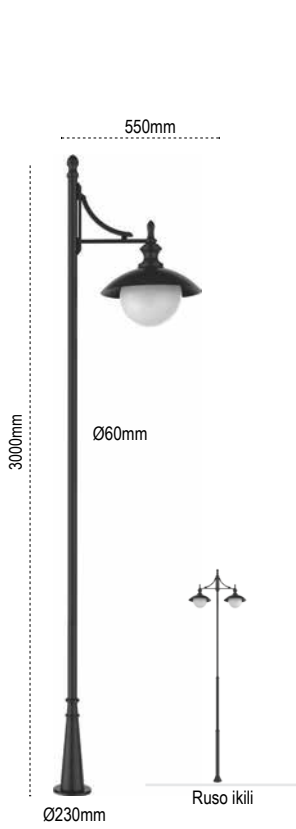

**Ruso**

Ø230mm

Ruso ikili

IP 54 ☺

Kod No	Özellikler	Koli Adedi	Fiyat
107461	Tekli Döküm Dipli Direk E27	1	278,25 \$
107463	İkili Döküm Dipli Direk E27	1	372,25 \$

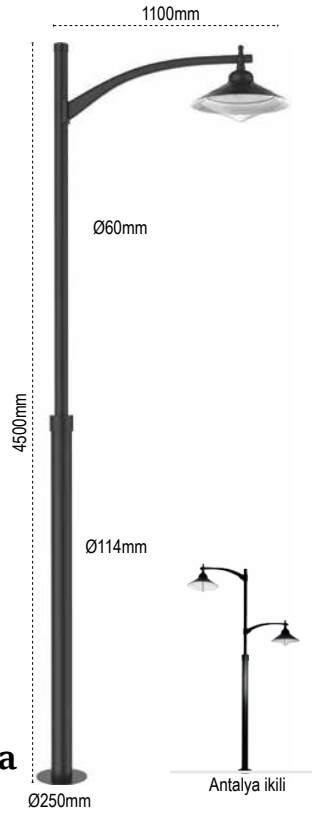

**Antalya**

Ø250mm

Antalya ikili

IP 54 ☺

Kod No	Özellikler	Koli Adedi	Fiyat
107531	Tekli Direk E27	1	314,50 \$
107532	İkili Direk E27	1	390,75 \$



**Pedesa**

Ø200mm

Pedesa ikili

IP 54 ☺

Kod No	Özellikler	Koli Adedi	Fiyat
107533	Tekli Gloplu Direk E27	1	139,75 \$
107517	İkili Gloplu Direk E27	1	232,75 \$
107530	Üçlü Gloplu Direk E27	1	330,25 \$

# Park Bahçe Aydınlatma Armatürleri **Pelsan**

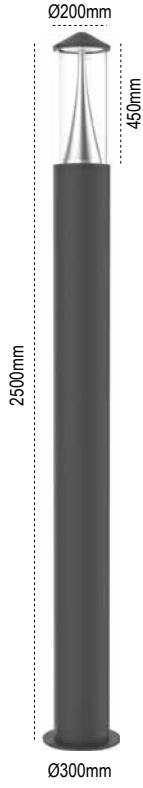

**Luzon**

Kod No	Özellikler	Koli Adedi	Fiyat
109736	40W 4000K	1	523,00 \$

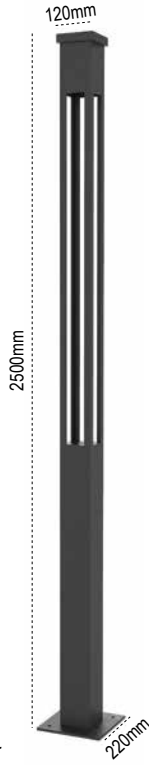

**Alinda**

Kod No	Özellikler	Koli Adedi	Fiyat
107467	35W LED 4000K	1	325,00 \$

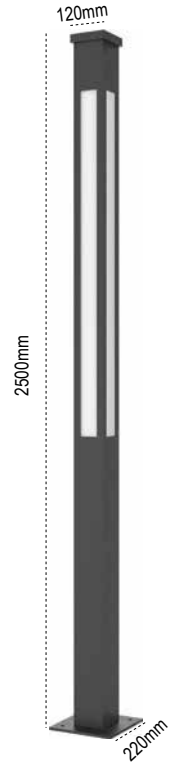

**Milas**

Kod No	Özellikler	Koli Adedi	Fiyat
108500	100W 4000K	1	812,00 \$

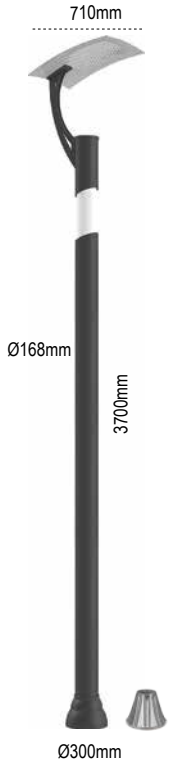

**Datça**

Kod No	Özellikler	Koli Adedi	Fiyat
107601	30W LED 6500K	1	784,00 \$

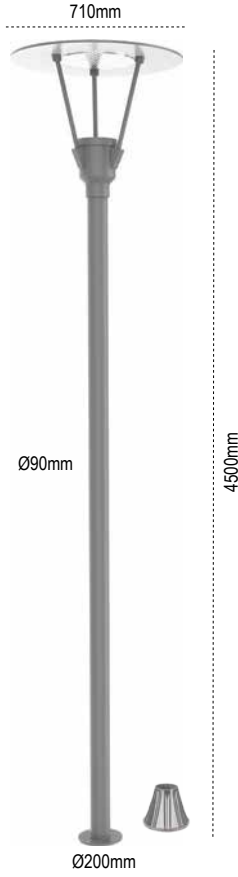

**Samos**

Kod No	Özellikler	Koli Adedi	Fiyat
108612	150W G12	1	627,00 \$
108163	50W LED 4000K	1	745,00 \$

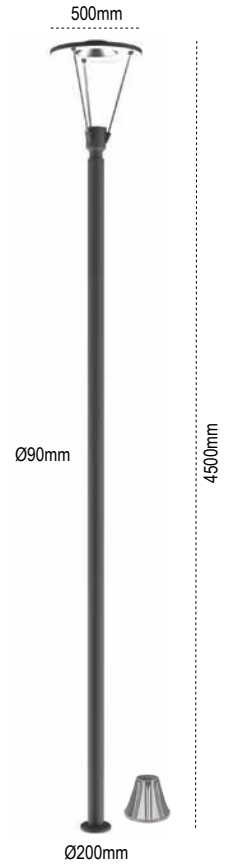

**Petra**

Kod No	Özellikler	Koli Adedi	Fiyat
107882	50W 4000K	1	510,00 \$

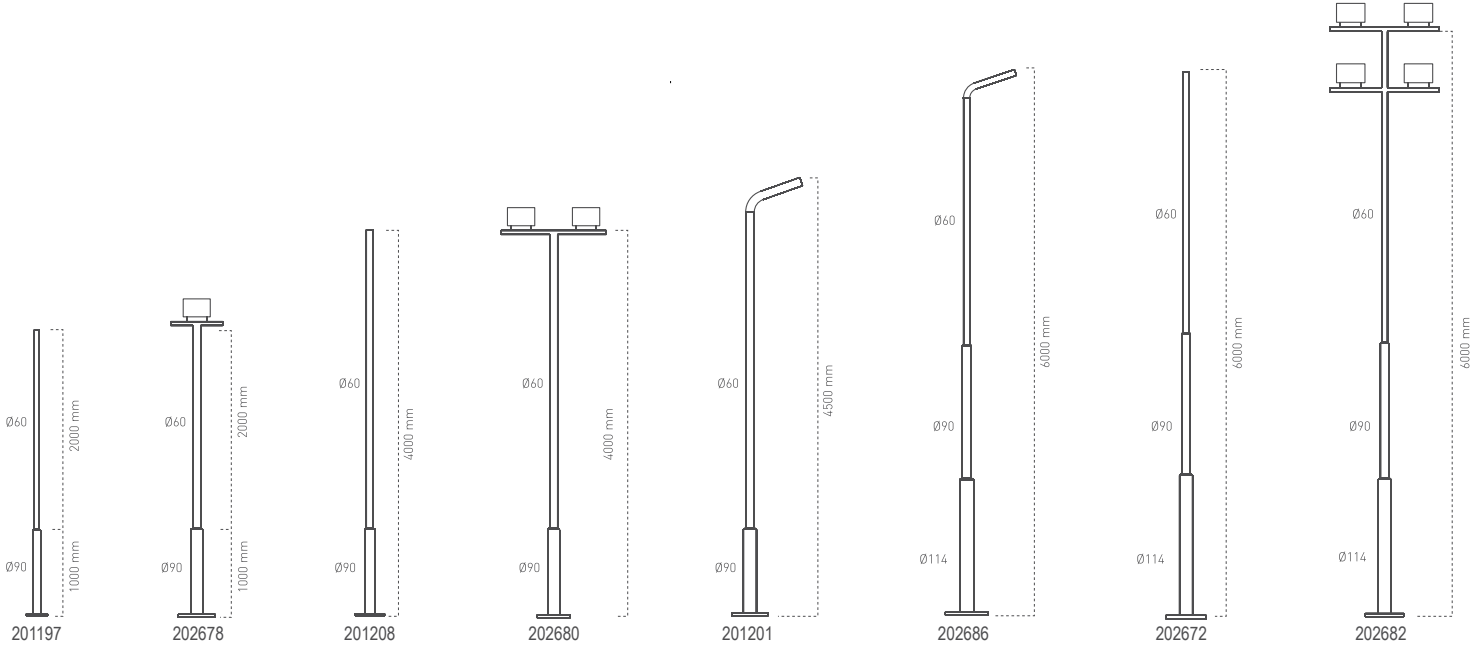

## Yol, Bahçe ve Projektör Direkleri

IP 65

Kod No	Özellikler	Koli Adedi	Fiyat
201197	3 m Kademeli Boru Direk	1	142,25 \$
202678	3 m 1 Projektörlük Boru Direk	1	153,25 \$
201208	4 m Kademeli Boru Direk	1	164,25 \$
202680	4 m 2 Projektörlük Direk	1	175,25 \$

Kod No	Özellikler	Koli Adedi	Fiyat
201201	4,5 m S. Lamba Direği	1	186,25 \$
202686	6 m S. Lamba Direği	1	295,50 \$
202672	6 m Kademeli Boru Direk	1	295,50 \$
202682	6 m 4 Projektörlük Direk	1	317,50 \$
312688	Ankraj 250mm Polyester	1	13,05 \$

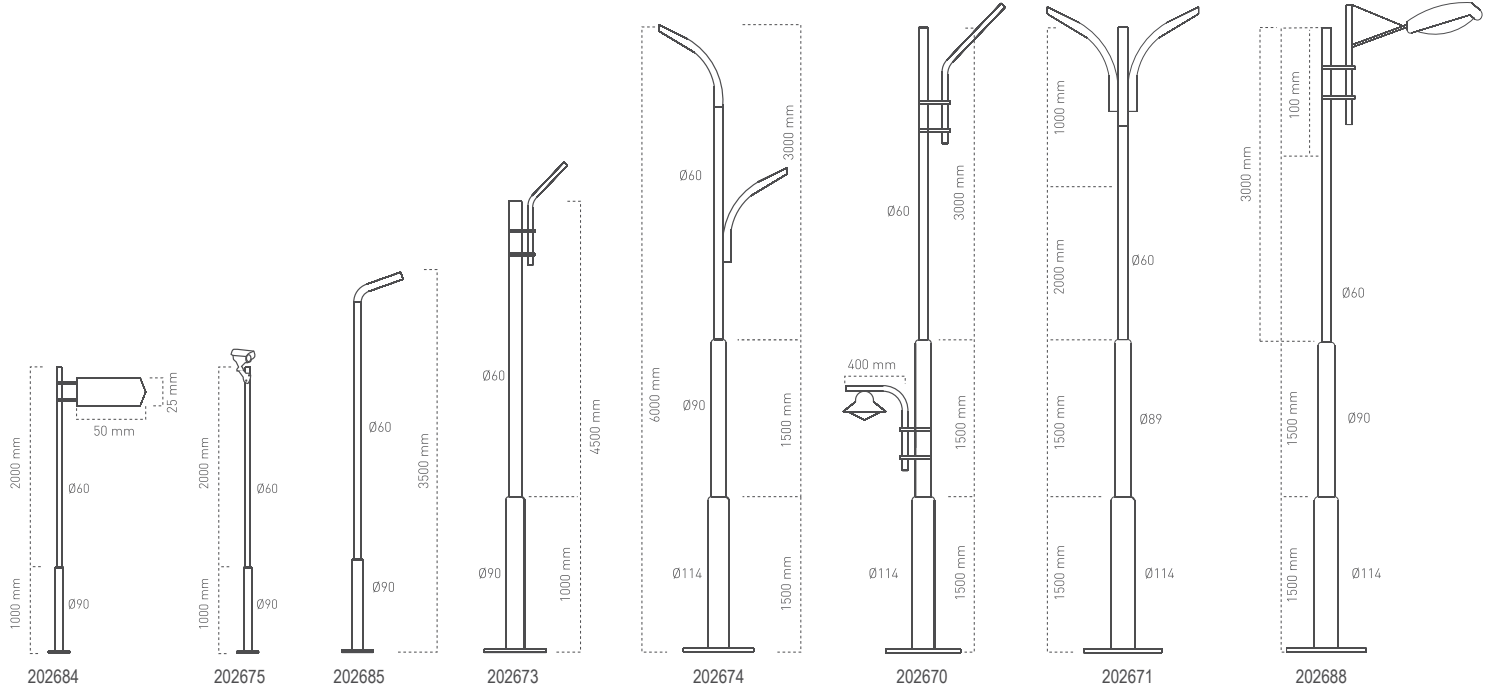

## Yol, Bahçe ve Projektör Direkleri

IP 65

Kod No	Özellikler	Koli Adedi	Fiyat
202684	3 m Sokak Direği	1	98,50 \$
202675	3 m Kamera Direği	1	120,50 \$
202685	3,5 m Sokak Lamba Direği	1	168,50 \$
202673	4,5 m 1 x Armatür Direği	1	186,25 \$
312688	Ankraj 250mm Polyester	1	13,05 \$

Kod No	Özellikler	Koli Adedi	Fiyat
202674	6 m 2xArmatür	1	317,50 \$
202670	6 m Çift Armatür Direği	1	339,25 \$
202671	6 m 2xKonsol Direği	1	317,50 \$
202688	6 m Armatür Direği	1	295,50 \$
312688	Ankraj 250mm Polyester	1	13,05 \$



### Luzon 2

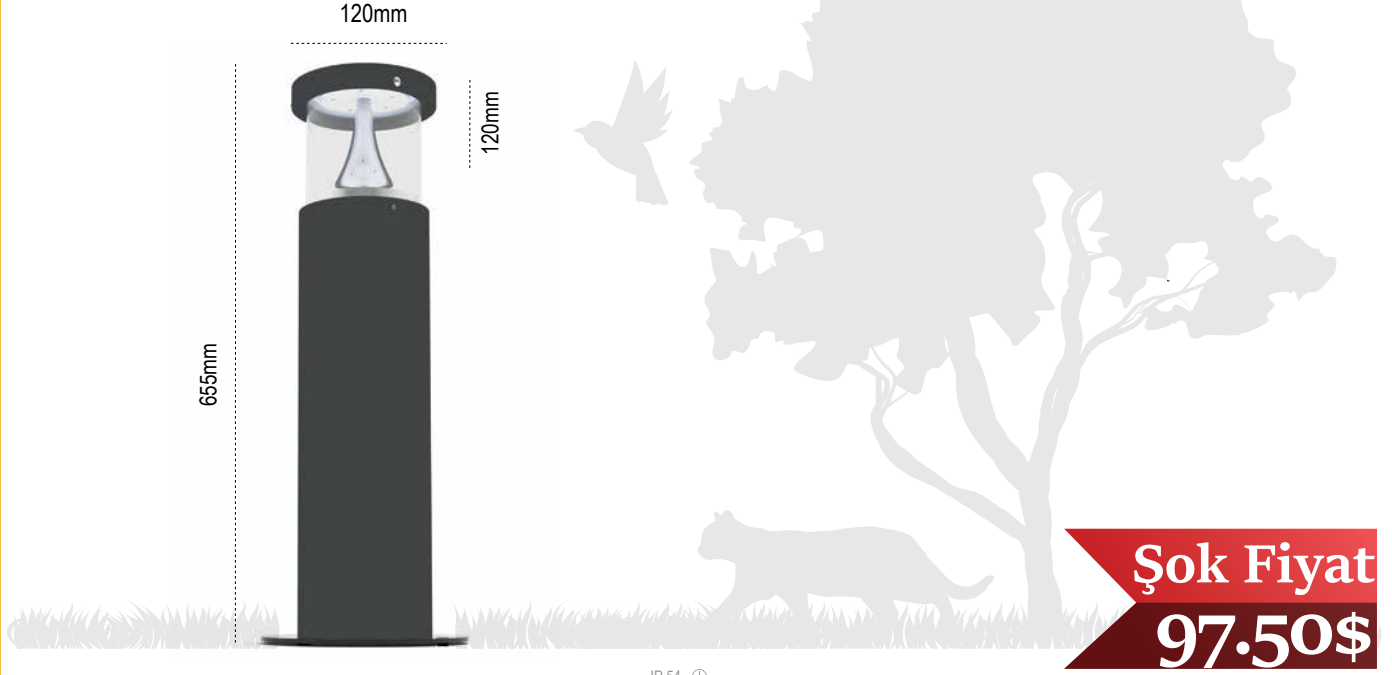

**Şok Fiyat**  
**97.50\$**

IP 54

Kod No	Özellikler	Koli Adedi	Fiyat
110753	14W 4000K	1	97,50 \$

### Bali



**Şok Fiyat**  
**139.50\$**

IP 65

Kod No	Özellikler	Koli Adedi	Fiyat
108870	18W 4000K	1	139,50 \$

# Pelsan Bolardlar



## Bali

IP 65 ☺

Kod No	Özellikler	Koli Adedi	Fiyat
108870	18W 4000K	1	139,50 \$

## Malta

IP 65 ☺

Kod No	Özellikler	Koli Adedi	Fiyat
108871	2x18W 4000K	1	209,50 \$

## Maldiv

IP 65 ☺

Kod No	Özellikler	Koli Adedi	Fiyat
108872	18W 4000K	1	155,75 \$

## Santorini

IP 65 ☺

Kod No	Özellikler	Koli Adedi	Fiyat
108873	2x18W 4000K	1	209,50 \$



## Pega

IP 54 ☺

Kod No	Özellikler	Koli Adedi	Fiyat
108878	18W 4000K	1	130,75 \$

## Mayorka

IP 54 ☺

Kod No	Özellikler	Koli Adedi	Fiyat
111419	18W 4000K	1	210,50 \$

## Alinda

IP 54 ☺

Kod No	Özellikler	Koli Adedi	Fiyat
108859	18W 4000K	1	161,50 \$

## Luzon

IP 54 ☺

Kod No	Özellikler	Koli Adedi	Fiyat
109027	20W 4000K	1	165,30 \$

## 10W Dış Mekan Spotu Erbaled



IP 65

Kod No	Özellikler	Koli Adedi	Fiyat
109359	10W 4000K	8	45,25 \$
109487	10W 6500K	8	45,25 \$
205288	Saplama Aparatı 21cm	10	4,75 \$

## 10W Dış Mekan Spotu Erbaled



IP 65

Kod No	Özellikler	Koli Adedi	Fiyat
109486	10W Amber	8	45,25 \$
109485	10W Yeşil	8	45,25 \$
205288	Saplama Aparatı 21cm	10	4,75 \$

## 10W Dış Mekan Spotu Erbaled

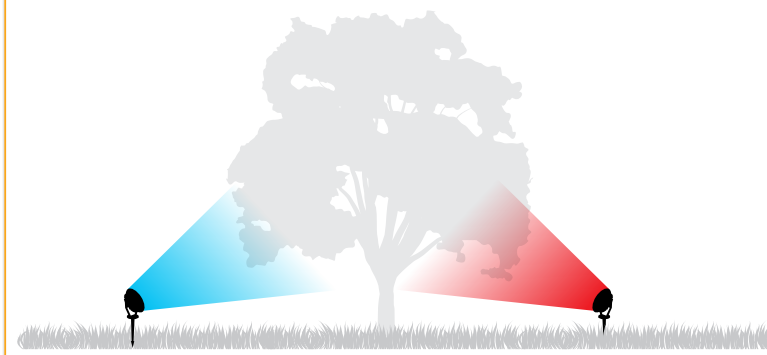

IP 65

Kod No	Özellikler	Koli Adedi	Fiyat
110818	10W Mavi	8	45,25 \$
109550	10W Kırmızı	8	45,25 \$
205288	Saplama Aparatı 21cm	10	4,75 \$

## Dış Mekan Spotu Santa

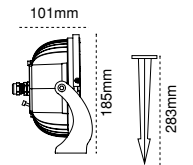

IP 65

Kod No	Özellikler	Koli Adedi	Fiyat
206767	15W 4000K	1	132,50 \$
206768	15W 6500K	1	132,50 \$
206770	25W 4000K	1	147,50 \$
206771	25W 6500K	1	147,50 \$
206773	37W 4000K	1	162,50 \$
206774	37W 6500K	1	162,50 \$

## Pelsan Setüstü Armatürler

### Alinda

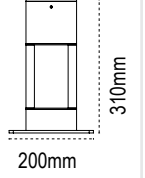

IP 65 ☹

Kod No Özellikler  
109401 15W 4000K

Koli Adedi Fiyat  
8 102,50 \$

### Pega

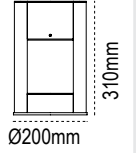

IP 65 ☹

Kod No Özellikler  
109403 15W 4000K

Koli Adedi Fiyat  
2 102,50 \$

### Luzon

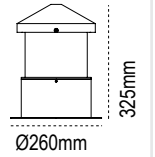

IP 54 ☹

Kod No Özellikler  
109402 15W 4000K

Koli Adedi Fiyat  
1 114,50 \$

### Tino

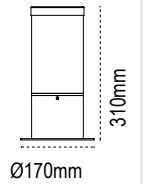

IP 54 ☹

Kod No Özellikler  
110709 E27

Koli Adedi Fiyat  
8 45,75 \$

## Işılay 1



Alüminyum  
Enjeksiyon



IP 54

Kod No	Özellikler	Koli Adedi	Fiyat
110742	1xE27 Duyulu	8	34,75 \$

## Işılay 2



Alüminyum  
Enjeksiyon

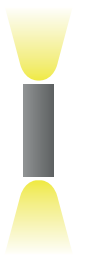

IP 54

Kod No	Özellikler	Koli Adedi	Fiyat
110743	2xE27 Duyulu	6	47,75 \$

## Tibat 1



Alüminyum  
Enjeksiyon



IP 54

Kod No	Özellikler	Koli Adedi	Fiyat
110744	E27 Duyulu	8	37,50 \$

## Tibat 2



Alüminyum  
Enjeksiyon

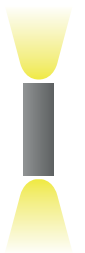

IP 54

Kod No	Özellikler	Koli Adedi	Fiyat
110745	2XE27 Duyulu	6	52,50 \$

## Pelsan Park Bahçe Aplikleri

### Grada Sensörlü

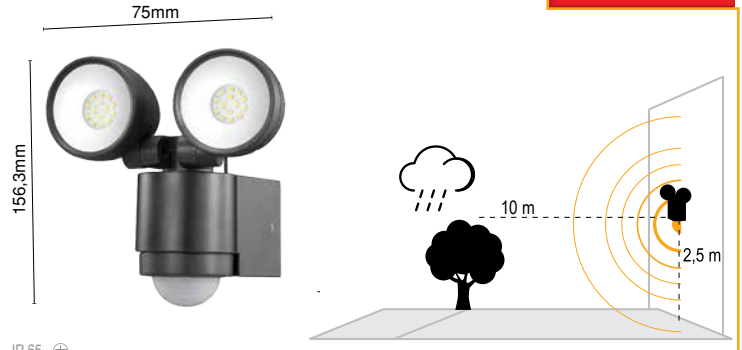

Yeni Ürün

IP 65

Kod No	Özellikler	Koli Adedi	Fiyat
113600	2x10W 4000K Sensörlü	8	47,00 \$

### IP54 Oval Kafes Alüminyum Enjeksiyon

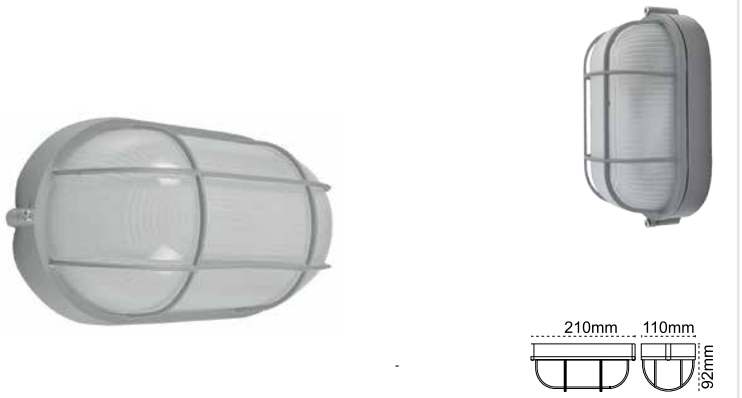

IP 54

Kod No	Özellikler	Koli Adedi	Fiyat
204487	E27 Duyulu	18	9,90 \$

### Işıközü Sensörlü

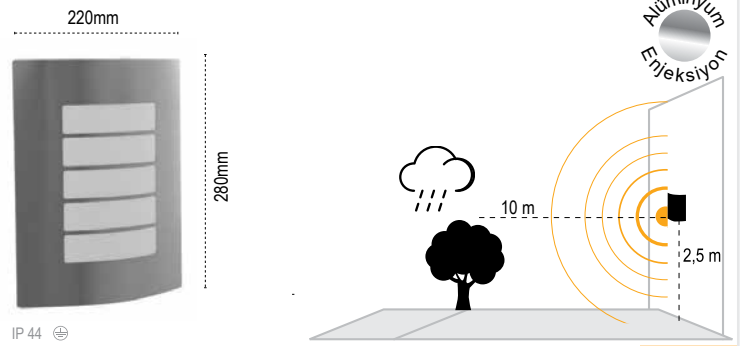

IP 44

Kod No	Özellikler	Koli Adedi	Fiyat
109297	E27 Duyulu Sensörlü	8	27,20 \$

### Havana G2 IP66

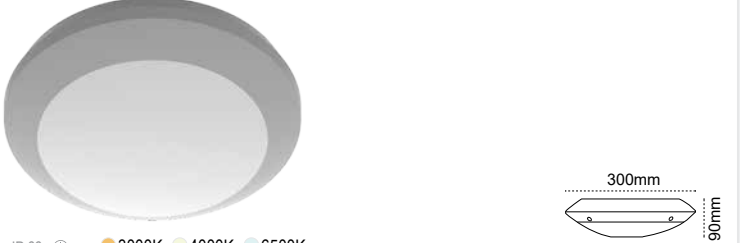

IP 66 3000K 4000K 6500K

Kod No	Özellikler	Koli Adedi	Fiyat
111193	E27	8	16,50 \$
111194	2XE27	8	17,60 \$
111220	E27 Sensörlü	8	30,50 \$
111223	2XE27 Sensörlü	8	31,60 \$
111226	15W 6500K	8	29,60 \$
111236	15W 6500K Sensör	8	43,60 \$
111245	15W 6500K Acil Ayd Kit	8	55,60 \$
111260	15W 6500K Sensör + Acil Ayd Kit	8	69,60 \$

## Led Lamba

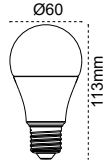

IP 54

Kod No	Özellikler	Koli Adedi	Fiyat
324261	8,5W 2700K E27 Ø60	100	1,03 \$
324262	8,5W 6500K E27 Ø60	100	1,03 \$

## Filament Lamba (Ø60)

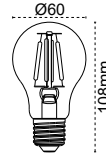

Kod No	Özellikler	Koli Adedi	Fiyat
313438	4W Filament Lamba E27 3000K	100	2,25 \$
313444	4W Filament Lamba E27 6500K	100	2,25 \$

## Buji Filament Lamba

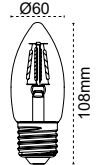

Kod No	Özellikler	Koli Adedi	Fiyat
313437	4W Buji Lamba E27 3000K	100	2,05 \$
313439	4W Buji Lamba E27 6500K	100	2,05 \$

## Filament Lamba (Ø64)

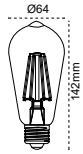

Kod No	Özellikler	Koli Adedi	Fiyat
313440	6W Filament E27 2700K	40	3,70 \$

## Filament Lamba (Ø95)

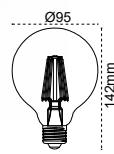

Kod No	Özellikler	Koli Adedi	Fiyat
313441	6W Filament E27 2700K	20	5,50 \$

## Filament Lamba (Ø125)



Kod No	Özellikler	Koli Adedi	Fiyat
313442	6W Filament E27 2700K	20	7,60 \$

## Filament Lamba (T20)

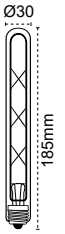

Kod No	Özellikler	Koli Adedi	Fiyat
318053	6W E27 T20	20	6,60 \$

## Yüksek Güçlü Lambalar

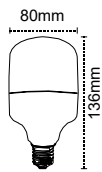

18W

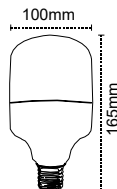

28W

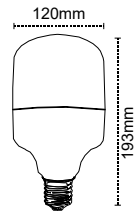

38W

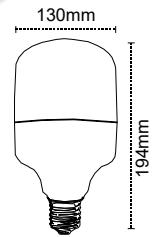

48W

Kod No	Özellikler	Koli Adedi	Fiyat	Kod No	Özellikler	Koli Adedi	Fiyat	Kod No	Özellikler	Koli Adedi	Fiyat	Kod No	Özellikler	Koli Adedi	Fiyat
325793	18 W 6500K E27	30	5,00 \$	325802	28W 6500K E27	20	7,05 \$	325810	38W 6500K E27	20	9,05 \$	325821	48W 6500K E27	20	11,05 \$

## Pelsan LED Tube

### LED Tube Pro



130lm/W



ABS Gövde

Kod No	Özellikler	Koli Adedi	Fiyat
323524	22W 6500K 150cm 135 lm/W	25	18,50 \$

### LED Tube Cam Gövde



Tek Taraftan  
Bağlantı



Enerji  
Tasarrufu



Kolay  
Kurulum



60 / 120 / 150 cm  
Boy Seçeneği

Kod No	Özellikler	Koli Adedi	Fiyat	Kod No	Özellikler	Koli Adedi	Fiyat
314663	9W 4000K 60cm	25	4,45 \$	314669	22W 4000K 150cm	25	9,70 \$
314664	9W 6500K 60cm	25	4,45 \$	314668	22W 6500K 150cm	25	9,70 \$
314666	18W 4000K 120cm	25	4,80 \$				
314665	18W 6500K 120cm	25	4,80 \$				

### Sensörlü LED Tube ABS Gövde LED Tube



Çift Taraftan  
Bağlantı



Çalışma Şekli

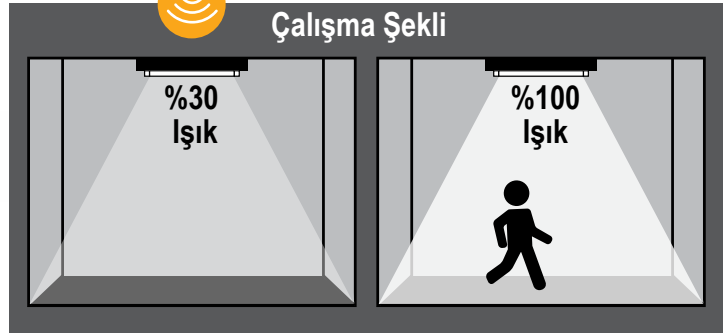

Kod No	Özellikler	Koli Adedi	Fiyat
315114	18W Sensör 6500K 120cm	25	14,40 \$

### LED Tube Konvertör Kit



IP 20

Kod No	Özellikler	Koli Adedi	Fiyat
313117	9-18W LED Tube Konvertör Kit	25	26,00 \$



## Y.B Metal Halide

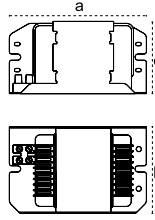

IP 40

Kod No	Özellikler	axbxcmm	Koli Adedi	Fiyat
313048	Metal Halide 35W	155x42x33	24	16,60 \$
313051	Metal Halide 70W	116x64x54	16	23,90 \$
313052	Metal Halide 150W	122x78x66	8	36,10 \$
313053	Metal Halide 250W	135x93x79	4	56,40 \$
313055	Metal Halide 400W	135x93x79	4	59,30 \$
313057	Metal Halide 1000W	197x126x138	2	160,10 \$
313059	Metal Halide 2000W (380V)	225x126x138	1	207,90 \$

## Y.B Sodyum Halide

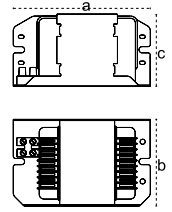

IP 40

Kod No	Özellikler	axbxcmm	Koli Adedi	Fiyat
313043	Sodyum Buharlı 400W	156x93x69	2	77,70 \$
313047	Sodyum Buharlı 600W	178x126x138	2	126,90 \$
313045	Sodyum Buharlı 1000W	197x126x138	2	160,10 \$

## Metal Kitler

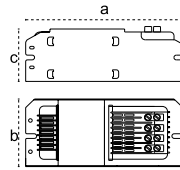

IP 20

Kod No	Özellikler	axbxcmm	Koli Adedi	Fiyat
200078	Metal Kit 35W Balast + ignitör	185x115x88	4	34,90 \$
200069	Metal Kit 70W Balast + ignitör	150x64x54	4	37,10 \$
200070	Metal Kit 150W Balast + ignitör	166x77x65	4	53,90 \$
200074	Metal Kit 250W Balast + ignitör	205x93x79	4	69,40 \$
200076	Metal Kit 400W Balast + ignitör	232x93x79	4	73,70 \$
105227	Olimpiad Kiti 1000W	246x126x138	1	232,90 \$

## Sera Kitler

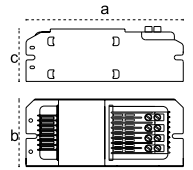

IP 20

Kod No	Özellikler	axbxcmm	Koli Adedi	Fiyat
200066	Sera 400W SB Balast Kiti	232x93x79	4	111,80 \$
200067	Sera 600W SB Balast Kiti	246x126x138	1	188,25 \$

## İgnitör

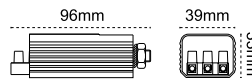

IP 20

Kod No	Özellikler	Koli Adedi	Fiyat
303902	Zaman Ayarlı 50-400W	10	9,40 \$
303880	İgnitör 70-400W	10	7,70 \$
303906	600-1000W (25 m kadar)	10	19,80 \$
303900	İgnitör 600-1000W	10	19,80 \$

## Lambalar

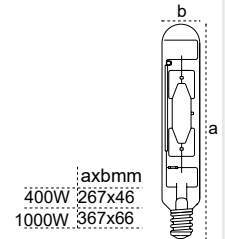
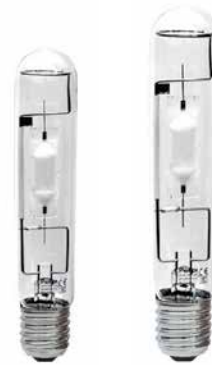

Kod No	Özellikler	Koli Adedi	Fiyat
313514	400W 5500K E40 Metal	24	15,00 \$
313512	1000W 5500K E40 Metal	20	50,00 \$

## Pelsan Sürücü ve Kitler

### LED Konvertör Kit (1 Saat/3 Saat)



IP 20

Kod No	Özellikler	Koli Adedi	Fiyat
327764	12-110V LED Konvertör Kit (1 Saat)	50	26,00 \$
327251	12-110V LED Konvertör Kit (3 Saat)	50	30,30 \$

### LED Tube Konvertör Kit



IP 20

Kod No	Özellikler	Koli Adedi	Fiyat
313117	9-18W LED Tube Konvertör Kit	25	26,00 \$

### IP20 Sabit Akım LED Sürücüler

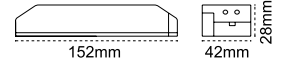

IP 20

Kod No	Özellikler	Koli Adedi	Fiyat
316981	36W 700 mA 40-51 V DC Çıkış Gerilimi	200	15,90 \$
316982	36W 800 mA 33-45 V DC Çıkış Gerilimi	200	15,90 \$
316983	36W 900 mA 30-40 V DC Çıkış Gerilimi	200	15,90 \$

### 60W 12V DC 5A Sabit Gerilim Sürücü



IP 20

Kod No	Özellikler	Koli Adedi	Fiyat
313240	60W 12V DC 5A	1	7,50 \$

### 100W 12V DC 8,5A Sabit Gerilim Sürücü



IP 20

Kod No	Özellikler	Koli Adedi	Fiyat
313242	100W 12V DC 8,5A	1	9,80 \$

### 150W 12V DC 12,5A Sabit Gerilim Sürücü



IP 20

Kod No	Özellikler	Koli Adedi	Fiyat
313244	150W 12V DC 12,5A	1	13,40 \$

### 200W 12V DC 16,5A Sabit Gerilim Sürücü



IP 20

Kod No	Özellikler	Koli Adedi	Fiyat
313246	200W 12V DC 16,5A	1	15,90 \$

### 250W 12V DC 21A Sabit Gerilim Sürücü



IP 20

Kod No	Özellikler	Koli Adedi	Fiyat
313252	250W 12V DC 21A	1	19,00 \$

### 360W 12V DC 30A Sabit Gerilim Sürücü



IP 20

Kod No	Özellikler	Koli Adedi	Fiyat
313248	360W 12V DC 30A	1	22,50 \$

## Keira Beyaz Anahtar ve Priz Serisi

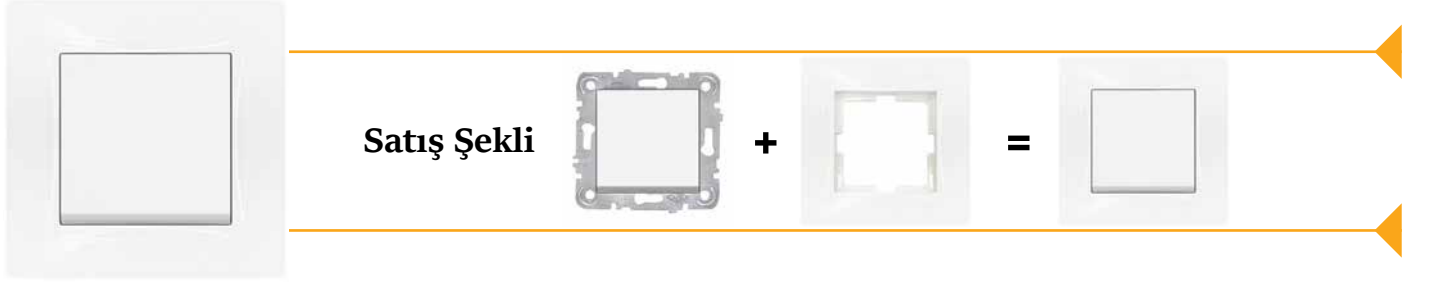
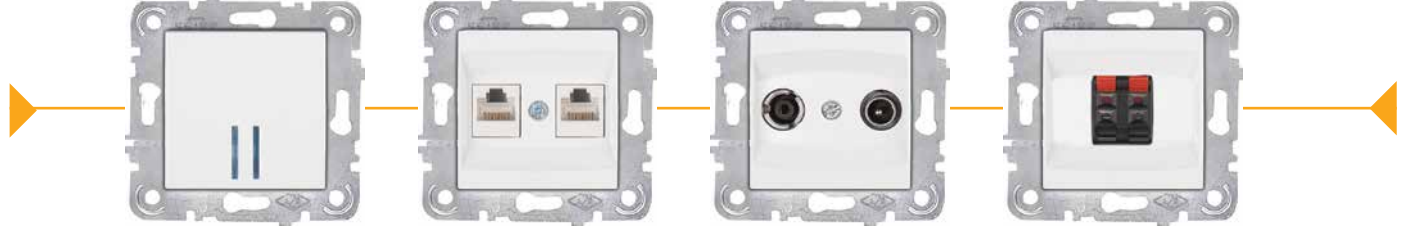

Kod No	Cinsi	Koli Ad.	Keira Beyaz & Krem Seri
<b>Anahtar Grubu</b>			
202558	Anahtar	120	2,75 \$
204991	Light	120	2,84 \$
204992	Kapı otomatığı	120	2,84 \$
204993	Zil anahtarı	120	2,84 \$
202561	Komitatör	120	3,34 \$
204994	Vavien	120	3,38 \$
204995	Permitatör	120	4,51 \$
204996	Komitatör vavien	120	4,51 \$
204997	Jaluzi anahtarı	120	5,28 \$
204998	Şofben anahtarı	120	4,65 \$
204999	3'lü anahtar	120	3,78 \$
<b>Priz Grubu</b>			
205000	Priz	120	3,13 \$
202563	Topraklı priz	120	3,41 \$
205001	Çocuk korumalı topraklı priz	120	4,31 \$
205002	UPS topraklı priz	120	4,00 \$
205153	UPS çocuk korumalı topraklı priz	120	4,51 \$
205004	Kapaklı topraklı priz	120	4,76 \$
205154	Çocuk korumalı kapaklı topraklı priz	120	4,90 \$
205006	UPS kapaklı topraklı priz	120	4,50 \$
<b>TV/Radyo Grubu</b>			
205009	TV priz geçişli	120	4,81 \$
205010	TV priz sonlu	120	4,81 \$
205011	TV priz dirençsiz	120	4,81 \$
205012	Uydu prizi F konnektörlü geçişli	120	6,01 \$
205013	Uydu prizi F konnektörlü sonlu	120	6,14 \$
205014	TV - Radyo priz geçişli	120	18,09 \$
205015	TV - Radyo priz sonlu	120	18,09 \$
205016	TV - Sat priz geçişli	120	17,65 \$
205007	TV - Sat priz sonlu	120	17,65 \$

Kod No	Cinsi	Koli Ad.	Keira Beyaz & Krem Seri
<b>iletişim Grubu</b>			
205008	Numeris telefon prizi (RJ11)	120	3,28 \$
205017	İkili numeris (RJ11)	120	5,14 \$
205018	Data numeris (RJ45CAT5-RJ11)	120	9,30 \$
205022	Data priz (RJ45CAT5)	120	9,30 \$
205020	İkili data priz (RJ45CAT5)	120	15,04 \$
205021	Data jaksız	120	3,28 \$
205022	Data priz (RJ45CAT6)	120	9,30 \$
205023	İkili data priz (RJ45CAT6)	120	15,04 \$
205024	Data - Numeris (RJ45CAT6-RJ11)	120	9,30 \$
205025	Müzik Yayın Prizi	80	6,54 \$
205026	VGA Prizi	80	18,25 \$
205031	Müzik yayın anahtarı	80	15,31 \$
<b>Dimmer Grubu</b>			
205027	Dimmer 600W	80	13,38 \$
205028	Dimmer 1000W	80	31,25 \$
205029	Dimmer vavien 600W	80	32,13 \$
205030	Dimmer RC 300W	80	37,50 \$
<b>İşıkli Anahtar Grubu</b>			
205032	İşıkli anahtar	120	4,13 \$
205033	İşıkli light	120	4,13 \$
205034	İşıkli komitatör	120	4,71 \$
205035	İşıkli vavien	120	4,75 \$
205036	İşıkli etiketli zil	120	4,21 \$
205037	İşıkli dimmer 600W	80	13,75 \$
205038	İşıkli dimmer 1000W	80	33,75 \$
205039	İşıkli dimmer vavien 600W	80	34,63 \$
205040	İşıkli dimmer RC 300W	80	40,00 \$
<b>Çerçeveler</b>			
205296	1'li çerçeve	200	0,64 \$
205297	2'li çerçeve yatay-dikey	200	1,83 \$
205298	3'lü çerçeve yatay-dikey	150	2,41 \$
205299	4'lü çerçeve yatay-dikey	50	3,75 \$
205300	5'li çerçeve yatay-dikey	50	4,20 \$
205301	6'li çerçeve yatay-dikey	50	4,38 \$

# Pelsan Grup Prizler

Belek Çocuk Korumalı  
Eviniz de Cebiniz de GÜVENDE!

5  
YIL  
GARANTİ



Çocuk Korumalı



Alev Almaz Gövde  
(850°C Isıya Dayanıklı)



Halojen Free Malzeme



Anahtarlı / Anahtarsız  
Opsiyonu



Duvara Askı



## 3'lü Çocuk Korumalı



Kod No	Cinsi	Koli Ad.	Fiyat
204975	3'lü Klemensli (5951 4030)	96	5,31 \$
204922	3'lü 2 mt Kablolu (5951 4032)	48	10,00 \$
204923	3'lü 3 mt Kablolu (5951 4033)	24	11,72 \$
204924	3'lü 5 mt Kablolu (5951 4035)	24	15,08 \$

## 3'lü Anahtarlı Çocuk Korumalı



Kod No	Cinsi	Koli Ad.	Fiyat
204977	3'lü Klemensli (5951 4130)	96	8,20 \$
204925	3'lü 2 mt Kablolu (5951 4132)	48	11,33 \$
204926	3'lü 3 mt Kablolu (5951 4133)	48	14,61 \$
204927	3'lü 5 mt Kablolu (5951 4135)	24	17,97 \$

## 4'lü Çocuk Korumalı



Kod No	Cinsi	Koli Ad.	Fiyat
204978	4'lü Klemensli (5951 4040)	72	6,88 \$
204929	4'lü 2 mt Kablolu (5951 4042)	36	11,56 \$
204930	4'lü 3 mt Kablolu (5951 4043)	36	13,28 \$
204931	4'lü 5 mt Kablolu (5951 4045)	24	16,64 \$

## 4'lü Anahtarlı Çocuk Korumalı



Kod No	Cinsi	Koli Ad.	Fiyat
204979	4'lü Klemensli (5951 4140)	72	9,77 \$
204932	4'lü 2 mt Kablolu (5951 4142)	36	14,45 \$
204933	4'lü 3 mt Kablolu (5951 4143)	36	16,17 \$
204934	4'lü 5 mt Kablolu (5951 4145)	24	19,53 \$

## 6'lı Çocuk Korumalı



Kod No	Cinsi	Koli Ad.	Fiyat
204980	6'lı Klemensli (5951 4060)	60	10,55 \$
204935	6'lı 2 mt Kablolu (5951 4062)	36	15,23 \$
204936	6'lı 3 mt Kablolu (5951 4063)	36	16,95 \$
204937	6'lı 5 mt Kablolu (5951 4065)	24	20,31 \$

## 6'lı Anahtarlı Çocuk Korumalı



Kod No	Cinsi	Koli Ad.	Fiyat
204981	6'lı Klemensli (5951 4160)	60	13,44 \$
204938	6'lı 2 mt Kablolu (5951 4162)	36	18,13 \$
204939	6'lı 3 mt Kablolu (5951 4163)	36	19,84 \$
204940	6'lı 5 mt Kablolu (5951 4165)	24	23,20 \$



Belek USB Grup Priz



**USB Anahtarlı**  
Çocuk Korumalı



Kod No	Cinsi	Koli Ad.	Fiyat
204985	Usb 3'lü 2 mt Kablolu (5951 4232)	36	29,84 \$
204986	Usb 3'lü 3 mt Kablolu (5951 4233)	36	32,27 \$
204987	Usb 3'lü 5 mt Kablolu (5951 4235)	24	37,34 \$

**Aksesuarlar**

Kod No	Cinsi	Koli Ad.	Aksesuar Serisi
204402	Topraksız Erkek Fiş	1000	1,22 \$
204401	Topraklı Erkek Fiş	500	1,72 \$
204400	Topraklı Dişi Fiş	250	1,95 \$
204399	Toprak Erkek L Modeli Fiş	500	1,72 \$



**Fişler**

Kod No	Cinsi	Koli Ad.	Fiş Prizler Serisi
204395	Fiş Priz 3'lü	100	5,16 \$
204396	Fiş Priz 4'lü	100	7,19 \$
204397	Fiş Priz Trio	100	5,47 \$



**ATEX Belgeleri**

ATEX Belgeli Pelsan Exproof armatürler, tehlikeli gaz ve toz maddelerinin bulunduğu, patlama riski olan ortamlarda güvenle kullanılabilir.

**IEP ENERGY PETROLEUM INSTITUTE** **IEP ATEX**

(1) **EU- Internal Production Control Certificate**  
 (2) **Equipment or Protective Systems Intended for use in Potentially Explosive Atmospheres**  
 Directive 2014/34/EU  
 (3) EU - Internal Production Control Certificate Number: **IEP 16 ATEX 0468**  
 (4) Product: **LED lighting fixtures, Pelsan xy series**  
 (5) Firm Name: **PELSAN AYDINLATMA SANAYİ VE TİCARET A.Ş.**  
 (6) Firm Address: **İmes Sanayi Sitesi A Blok 101 Sokak No:38 Dudullu Ümraniye- İSTANBUL, TURKEY**  
 (7) This product any of acceptable variation thereto is specified in the schedule to this certificate and the documents therein referred to.  
 (8) The IEP Uluslararası Enerji Petrol Güçüm, Sertifikasyon ve Teknik Hizmetler Organizasyonu Tic. Ltd. Şti., notified body number 2284 in accordance with Article 17 of the Directive 2014/34/EU of European Parliament and of the Council, dated 26 February 2014, certifies that this product has been found to comply with the Essential Health and Safety Requirements relating to the design and construction of products intended for use in potentially explosive atmospheres, given in Annex II VIII to the Directive. The examination and test results are recorded in confidential Report No: IEP.Rp.Ex.10-1037 date 18.11.2016.  
 (9) Compliance with Essential Health and safety requirements has been assured by compliance with:  
**EN 60079-0 : 2012, EN 60079-15 : 2010, EN 60079-31 : 2009**  
 (10) If the sign "X" is placed after the certificate number, it indicates that the product is subject to Specified Conditions of Safe Use specified in the schedule to this certificate.  
 (11) This EU-Internal Production Control Certificate relates only to the design and construction of the specified product in accordance to the directive 2014/34/EU. Further requirements of the directive apply to the manufacturing process and supply of this product. These are not covered by this certificate. Validity date 10 year. If standard or product change, this certificate is invalid.  
 (12) The marking of the equipment or protective system shall include the following:

**II 3G Ex nR IIC T5 Gc**  
**II 3D Ex tc IIC ( T 95 °C ) Dc**

Responsible Person :  
 Nurgün Terzioğlu  
 Head of Certification Body

Date of Issue : 22.11.2016

IEP Uluslararası Enerji Petrol Güçüm, Sertifikasyon ve Teknik HİZ. Örg. Tic. Ltd. Şti.  
 33461 Sok. No:9 K:2 Beşiktaş - 34098 / TÜRKİYE  
 Tel : +90 212 431 17 45 - 46 Fax : +90 212 431 17 30 E-mail: info@iep.com.tr Tr 45  
 This certificate is granted subject to the general conditions of the IEP Energy Petroleum Institute. This certificate may only be reproduced in its entirety and without any change, schedule included. You can check accuracy of this document by www.iep.com.tr  
 Page | 1 / 2

**IEP ENERGY PETROLEUM INSTITUTE** **IEP ATEX**

(1) **Type Examination Certificate**  
 (2) **Equipment or Protective Systems Intended for use in Potentially Explosive Atmospheres**  
 Directive 2014/34/EU  
 (3) Type Examination Certificate Number: **IEP 18 ATEX 0597**  
 (4) Equipment: **Large Type, Exproof Luminaires**  
 (5) Firm Name: **PELSAN AYDINLATMA SANAYİ VE TİCARET A.Ş.**  
 (6) Firm Address: **İmes Sanayi Sitesi A Blok 101 Sok. No:38 Y. Dudullu - İSTANBUL, TURKEY**  
 (7) This equipment or protective system and any of acceptable variation thereto is specified in the schedule to this certificate and the documents therein referred to.  
 (8) The IEP Uluslararası Enerji Petrol Güçüm, Sertifikasyon ve Teknik Hizmetler Organizasyonu Tic. Ltd. Şti., certifies that this equipment or protective system has been found to comply with the Essential Health and Safety Requirements relating to the design and construction of category 3 equipment, which is intended for use in potentially explosive atmospheres, given in Annex II to the Council Directive 2014/34/EU. The examination and test results are recorded in confidential Report No: IEP.Rp.Ex.10-1281 date 28.05.2018.  
 (9) Compliance with Essential Health and safety requirements has been assured by compliance with:  
**EN 60079-0:2013, EN 60079-15:2010, EN 60079-31:2014**  
 (10) If the sign "X" is placed after the certificate number, it indicates that the product is subject to Specified Conditions of Safe Use specified in the schedule to this certificate.  
 (11) This Type Examination Certificate relates only to the design and specification for construction of the equipment or protective system. It does not cover process for actual manufacture or supply of the equipment or protective system, for which further requirements of the directive are applicable.  
 (12) The marking of the equipment or protective system shall include the following:

**II 3G Ex nR IIC T5 Gc**  
**II 3D Ex tc IIC T 80° C Dc**

Responsible Person:  
 Nurgün Terzioğlu  
 Head of Certification Body

Date of Issue: 31.05.2018

IEP Uluslararası Enerji Petrol Güçüm, Sertifikasyon ve Teknik HİZ. Örg. Tic. Ltd. Şti.  
 33461 Sok. No:9 K:2 Beşiktaş - 34098 / TÜRKİYE  
 Tel : +90 212 431 17 45 - 46 Fax : +90 212 431 17 30 E-mail: info@iep.com.tr Tr 45  
 This certificate is granted subject to the general conditions of the IEP Energy Petroleum Institute. This certificate may only be reproduced in its entirety and without any change, schedule included. You can check accuracy of this document by www.iep.com.tr  
 Page | 1 / 2

**Türk Akreditasyon Sertifikası**

Türk Akreditasyon Kurumu tarafından akredite olan laboratuvarımız ile tüm aydınlatma armatürlerini standartlara uygun olarak test ediyoruz.

**TÜRKAK TÜRK AKREDİTASYON KURUMU**

**AKREDİTASYON SERTİFİKASI**

Deney Laboratuvarı olarak faaliyet gösteren,

**PELSAN AYDINLATMA SANAYİ VE TİCARET A.Ş. Pelsan Aydınlatma Laboratuvarı**

Cerkezli OSB İmes 5. Cadde 400 Acil 6 Parsel Dış Kapı No:12 Döviz: KOCAELİ / TÜRKİYE

TÜRKAK tarafından yapılan denetim sonucunda TS EN ISO/IEC 17025:2017 Standardına göre Ex te yer alan kapsamlarında akredite edilmiştir.

Akreditasyon No : AB-0795-T  
 Akreditasyon Tarihi : 28 Nisan 2015  
 Revizyon Tarihi / No : 27 Ağustos 2019 / 04

Bu Sertifika, yukarıda açık adı ve adresi yazılı Kuruluşun TS EN ISO/IEC 17025:2017 Standardına İlgili Yönetmelik ve Tebliğlere uygunluğunu sürdürmesi halinde, 26 Ağustos 2023 tarihine kadar geçerlidir.

Orbay EVRENSEVDİ  
 Genel Sekreter V.

Türk Akreditasyon Kurumu (TÜRKAK) ISO/IEC 17025 alanında Avrupa Akreditasyon Birliği (EA) ve Uluslararası Laboratuvar Akreditasyon Birliği (ILAC) ile çok taraflı anlaşma (MLA/MRA) imzalamıştır.

7701-040 -90 212 410 82 00 - www.turkak.org.tr

TSE Belgeleri



Yol ve Caddede Armatürleri



Projektörler



Genel Amaçlı Sabit Armatürler



Siva Altı Armatürleri

ENEC Belgeleri



Projektörler



Projektörler



Yol ve Caddede Armatürleri

**EAC Belgeleri**

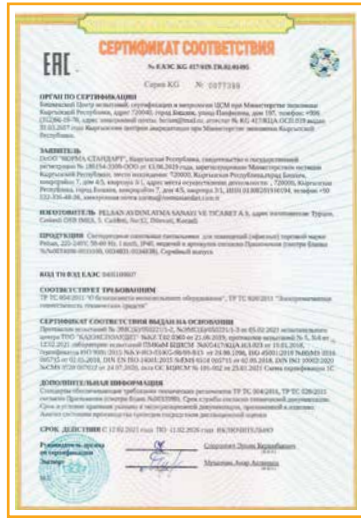

Ofis Armatürler

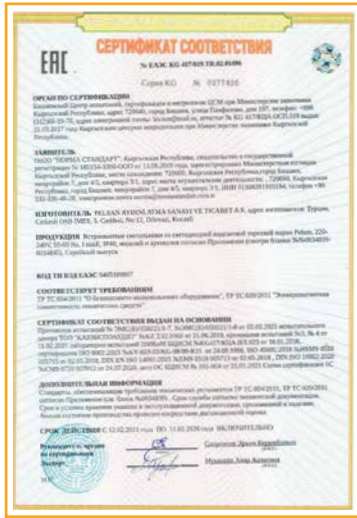

Downlight



Acil Aydınlatma Armatürleri



Acil Aydınlatma ve Yönlendirme Armatürler



Etanj Armatürler



Yüksek Tavan Armatürler



Projektörler



Yol ve Cade Armatürleri



Yerli Malı Belgeleri



Genel Amaçlı Sabit Armatürler

LED'li Genel Amaçlı Armatürler

Sıva Altı Armatürler



Etanj Armatürler



Yol ve Cadde Armatürleri



Projektörler



*yeni*  
**Mimari Aydınlatma**  
Markamız

 **recta**  
art and light

[www.rectalighting.com](http://www.rectalighting.com)





Yeni\*  
400W

~~535,00\$~~  
425,80\$

- W 200-400W
- 154lm/W'a Varan Verimlilik
- IP66 Toz ve Su Geçirmez
- IP67 ENEC Belgeli Sürücü
- 100.000h Sürücü Ömrü
- 10kV Dahili Parafudr



#### Lens Opsiyonları

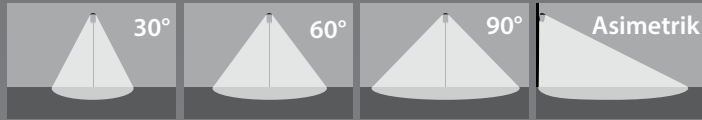

Güncel ürün bilgisi ve belgeleri için [www.pelsan.com.tr](http://www.pelsan.com.tr)'yi ziyaret ediniz.

[www.pelsan.com.tr](http://www.pelsan.com.tr)

[info@pelsan.com.tr](mailto:info@pelsan.com.tr) | [export@pelsan.com.tr](mailto:export@pelsan.com.tr)

